



Mobile Hydraulic Pumps T6*M

Denison Vane Technology, fixed displacement

aerospace
climate control
electromechanical
filtration
fluid & gas handling
hydraulics
pneumatics
process control
sealing & shielding



ENGINEERING YOUR SUCCESS.

Contents

GENERAL	Features	3
	Instructions	3
	Minimum & maximum speeds	4
	Pressure ratings	4
	Priming at starting	4
	Minimum allowable inlet pressure.....	5
	General characteristics.....	5
	Pump selection : Routine and example	6
	Intermittent pressure rating.....	6
	Description	7
	Application advantages	7
	Shafts and hydraulic fluids.....	8
	Notes	9
T6CM	Ordering code & Technical data.....	10
	Dimensions & Operating characteristics.....	11
T6CP	Ordering code & Technical data.....	12
	Dimensions & Operating characteristics.....	13
T6D*	Ordering code & Technical data.....	14
	Dimensions & Operating characteristics.....	15
T6E*	Ordering code & Technical data.....	16
	Dimensions & Operating characteristics.....	17
T6CC*	Ordering code & Technical data.....	18
	Dimensions & Operating characteristics.....	19
T6DC*	Ordering code & Technical data.....	20
	Dimensions & Operating characteristics.....	21
T6EC*	Ordering code & Technical data.....	22
	Dimensions & Operating characteristics.....	23
T6ED*	Ordering code & Technical data.....	24
	Dimensions & Operating characteristics.....	25
T6DCCM	Ordering code & Operating characteristics.....	26
	Dimensions.....	27
	Technical data.....	28
T6EDC*	Technical data.....	29
	Dimensions T6EDCM	30
	Dimensions T6EDCS.....	31
	Ordering code & Operating characteristics.....	32
	Additional shafts	33
	Porting diagrams for double pumps.....	34
	Porting diagrams for triple pumps.....	34 - 35

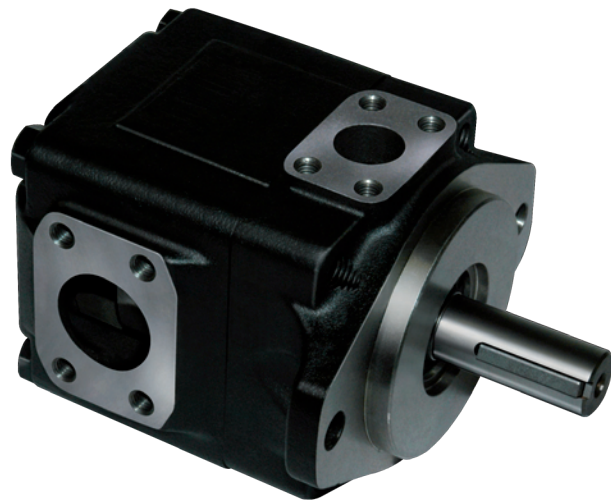

GREATER FLOW

Greater flow for the envelope size is achieved by increased displacement cam rings at high permissible speeds with atmospheric inlet
 C → 3 to 31 GPM, 10 to 100 ml/rev.
 D → 14 to 50 GPM, 48 to 158 ml/rev.
 E → 42 to 72 GPM, 132 to 227 ml/rev.

HIGHER PRESSURE

Pressure ratings to 275 bar reduce size and cost of actuators, valves and lines, give extended life at reduced pressures.

BETTER EFFICIENCY

Better efficiency under load increases productivity, reduces heating and operating costs.

MOUNTING FLEXIBILITY

Up to 32 positions for double pumps and up to 128 for triple pumps: this reduces mounting costs and improves performance.

LOWER NOISE LEVELS

Increase operator safety and acceptance.

COMPLETE CONFORMITY

To SAE - J744c 2-bolt standards and to ISO 3019-1 (T6EDCS SAE E, T6EDCM ISO 3019/2) in the various keyed and splined shaft options offered.

CARTRIDGE DESIGN

Provides for drop-in assemblies. This allows easy conversion or renewal of serviceable elements in minutes at minimum expense and risk of contamination. The "C" & "D" cartridge pumps are birotational and indicated by "B" description in cartridge model number. Pump rotation is easy to change by changing position of cam ring on port plate dowel pin hole.

WIDER RANGE OF ACCEPTABLE VISCOSITIES

Viscosities from 2000 to 10 cSt permit colder starts and hotter running. The balanced design compensates for wear and temperature changes. At high viscosity or cold temperature, the rotor to side plates gap is well lubricated and improves mechanical efficiency.

FIRE RESISTANT FLUIDS

Including phosphate esters, chlorinated hydrocarbons, water glycols and invert emulsions may be pumped at higher pressures and with longer service life by these pumps.

GENERAL APPLICATIONS INSTRUCTIONS

1. Check speed range, pressure, temperature, fluid quality, viscosity and pump rotation.
2. Check inlet conditions of the pump, if it can accept application requirement.
3. Type of shaft : if it would support operating torque.
4. Coupling must be chosen to minimize pump shaft load (weight, misalignment).
5. Filtration : must be adequate for lowest contamination level.
6. Environment of pump : to avoid noise reflection, pollution and shocks.

Size	Series	Theoretical Displacement Vi	Minimum Speed	Maximum Speed		Maximum Pressure					
				HF-0, HF-1 HF-2	HF-3, HF-4 HF-5	HF-0, HF-2		HF-1, HF-4, HF-5		HF-3	
		ml/rev.		RPM	RPM	RPM	Int.	Cont.	Int.	Cont.	Int.
CM CP	B03	10,8	400	2800	1800	275	240	210	175	175	140
	B05	17,2									
	B06	21,3									
	B08	26,4									
	B10	34,1									
	B12	37,1									
	B14	46,0									
	B17	58,3									
	B20	63,8									
	B22	70,3									
	B25	79,3									
	B28	88,8									
B31	100,0										
DM DP	B14	47,6	400	2500	1800	240	210	210	175	175	140
	B17	58,2									
	B20	66,0									
	B24	79,5									
	B28	89,7									
	B31	98,3									
	B35	111,0									
	B38	120,3									
	B42	136,0									
	B45	145,7									
	B50	158,0									
EM EP	042	132,3	400	2200	1800	240	210	210	175	175	140
	045	142,4									
	050	158,5									
	052	164,8									
	062	196,7									
	066	213,3									
	072	227,1									

HF-0, HF2 = Antiwear Petroleum Base
 HF-1 = Non Antiwear Petroleum Base
 HF-5 = Synthetic Fluids
 HF-3 = Water in oil Emulsions
 HF-4 = Water Glycols

For further information or if the performance characteristics outlined above do not meet your own particular requirements, please consult your local Parker office.

PRIMING AT STARTING

At first, start operation of the pump shaft at the lowest speed and at the lowest pressure to obtain priming. When a pressure relief valve is used at the outlet, it should be backed off to minimize return pressure.

When possible, an air bleed off should be provided in the circuit to facilitate purging of system air.

Never operate pump shaft at top speed and pressure without checking for completion of pump priming, and the fluid has no aeration disaerated.

Minimum allowable inlet pressure (bar absolute) Series T6 Mobile, Denison Vane Pumps

Cartridge		Speed RPM								Series				
Size	Series	1200	1500	1800	2100	2200	2300	2500	2800					
CM CP	B03	0,80	0,80	0,80	0,80	0,80	0,80	0,90	1,00	B03				
	B05									B05				
	B06									B06				
	B08									B08				
	B10									B10				
	B12									B12				
	B14									B14				
	B17									B17				
	B20									B20				
	B22									B22				
	B25									B25				
	B28									B28				
B31	B31													
DM DP	B14	0,80	0,80	0,80	0,80	0,88	0,95	1,00	1,00	B14				
	B17				B17									
	B20				B20									
	B24				0,82					1,10	B24			
	B28				0,85					0,92	1,00	1,18	B28	
	B31				0,90					0,95	1,00	1,23	B31	
	B35				0,92					0,98	1,02	1,29	B35	
	B38				0,95					1,00	1,05		B38	
	B42									1,02	1,08		B42	
	B45				0,85					0,98	1,05		B45	
B50		1,02	1,09		B50									
EM EP	042	0,80	0,80	0,80	0,88	1,00	1,00	1,00	1,00	042				
	045				045									
	050				050									
	052				052									
	062				0,85					0,95	062			
	066				0,85					0,85	0,95	1,00	1,09	066
	072				0,85					0,85	0,95	1,00	1,05	072

Inlet pressure is measured at inlet flange with petroleum base fluids at viscosity between 10 and 65 cSt. The difference between inlet pressure at the pump flange and atmospheric pressure must not exceed 0.2 bar to prevent aeration.

Multiply absolute pressure by 1,25 for HF-3, HF-4 fluids.

by 1,35 for HF-5 fluid.

by 1,10 for ester or rapeseed base.

Use highest cartridge absolute pressure for double & triple pump.

GENERAL CHARACTERISTICS

	Mounting standard	Weight without connector and bracket - kg	Moment of inertia kgm ² x 10 ⁻⁴	SAE 4 bolts			
				J518c - ISO/DIS 6162-1 - ⁴⁾ ISO/DIS 6162-2			
				Suction	Pressure		
T6CM	SAE J744c ISO/3019-1 SAE B	15,7	7,5	1.1/2"	1"		
T6CP	SAE J744c ISO/3019-1 SAE C	18,0	7,8	2 ⁴⁾	1.1/4 ⁴⁾		
T6D*		24,0	23,3	2"	1.1/4"		
T6E*		43,3	51,5	3"	1.1/2"		
T6CC*	SAE J744c ISO/3019-1 SAE B	26,0	14,9	2.1/2" or 3"	P1 1"	P2 1" or 3/4"	
T6DC*	SAE J744c ISO/3019-1 SAE C	36,6	30,4	3"	1.1/4"	1"	
T6EC*		55,0	73,4	3.1/2"	1.1/2"	1"	
T6ED*		66,0	73,4	4"	1.1/2"	1"1/4	
T6DCC*		61,0	37,3	4"	P1 1.1/4"	P2 1"	P3 1" or 3/4"
T6EDC*	SAE "E" (T6EDCS) ISO/3019-2 (T6EDCM)	100,0	80,2	4"	1.1/2"	1.1/4"	1" or 3/4"

CALCULATION

<i>To resolve</i>			Performances required
Volumetric displacement	V_i [ml/rev.]	Requested flow	Q [l/min] 60
Available flow	Q [l/min]	Speed	n [R.P.M.] 1500
Input power	P [kW]	Pressure	p [bar] 150

ROUTINE AND EXAMPLE

Routine :

Example :

1. First calculation $V_i = \frac{1000 Q}{n}$ $V_i = \frac{1000 \times 60}{1500} = 40 \text{ ml/rev}$

2. Choice V_i of pump immediately greater (see tabulation) T6CM B14 $V_i = 46 \text{ ml/rev}$.

3. Theoretical flow of this pump $Q_{theo.} = \frac{V_i \times n}{1000}$ $Q_{theo.} = \frac{46 \times 1500}{1000} = 69 \text{ l/min}$

4. Find $Q_{per.}$ leakage function of pressure $Q_{per.} = f(p)$ on curve at 10 or 24 cSt T6CM (page 10) : $Q_{per.} = 5 \text{ l/min}$ at 150 bar, 24 cSt

5. Available flow $Q = Q_{theo.} - Q_{per.}$ $Q = 69 - 5 = 64 \text{ l/min}$

6. Theoretical input power $P_{theo.} = \frac{Q_{theo.} \times p}{600}$ $P_{theo.} = \frac{69 \times 150}{600} = 17,3 \text{ kW}$

7. Find P_s hydrodynamic power loss on curve T6CM (page 10) : P_s at 1500 R.P.M., 150 bar = 1,5 kW

8. Calculation of necessary input power $P_{eff.} = P_{theo.} + P_s$ $P = 17,3 + 1,5 = 18,8 \text{ kW}$

9. Results
 $V_i = 46,0 \text{ ml/rev}$
 $Q_{eff.} = 64,0 \text{ l/min}$
 $P_{eff.} = 18,8 \text{ kW}$
 } T6CM B14

These calculation steps must be followed for each application.

INTERMITTENT PRESSURE RATING

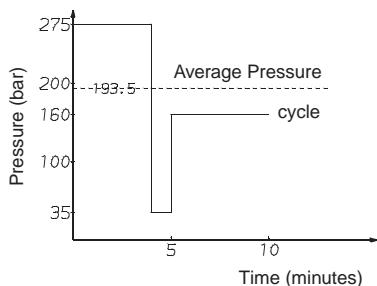

T6 units may be operated intermittently at pressures higher than the recommended continuous rating when the time weighted average of pressure is less than or equal to the continuous duty pressure rating.

This intermittent pressure rating calculation is only valid if other parameters; speed, fluid, viscosity and contamination level are respected.

For total cycle time higher than 15 minutes, please consult your Parker representative.

Example : T6CM - B14
 Duty cycle 4 min. at 275 bar
 1 min. at 35 bar
 5 min. at 160 bar

$$\frac{(4 \times 275) + (1 \times 35) + (5 \times 160)}{10} = 193,5 \text{ bar}$$

193,5 bar is lower than 240 bar allowed as continuous pressure for T6CM - B14 with HF-0 fluid.

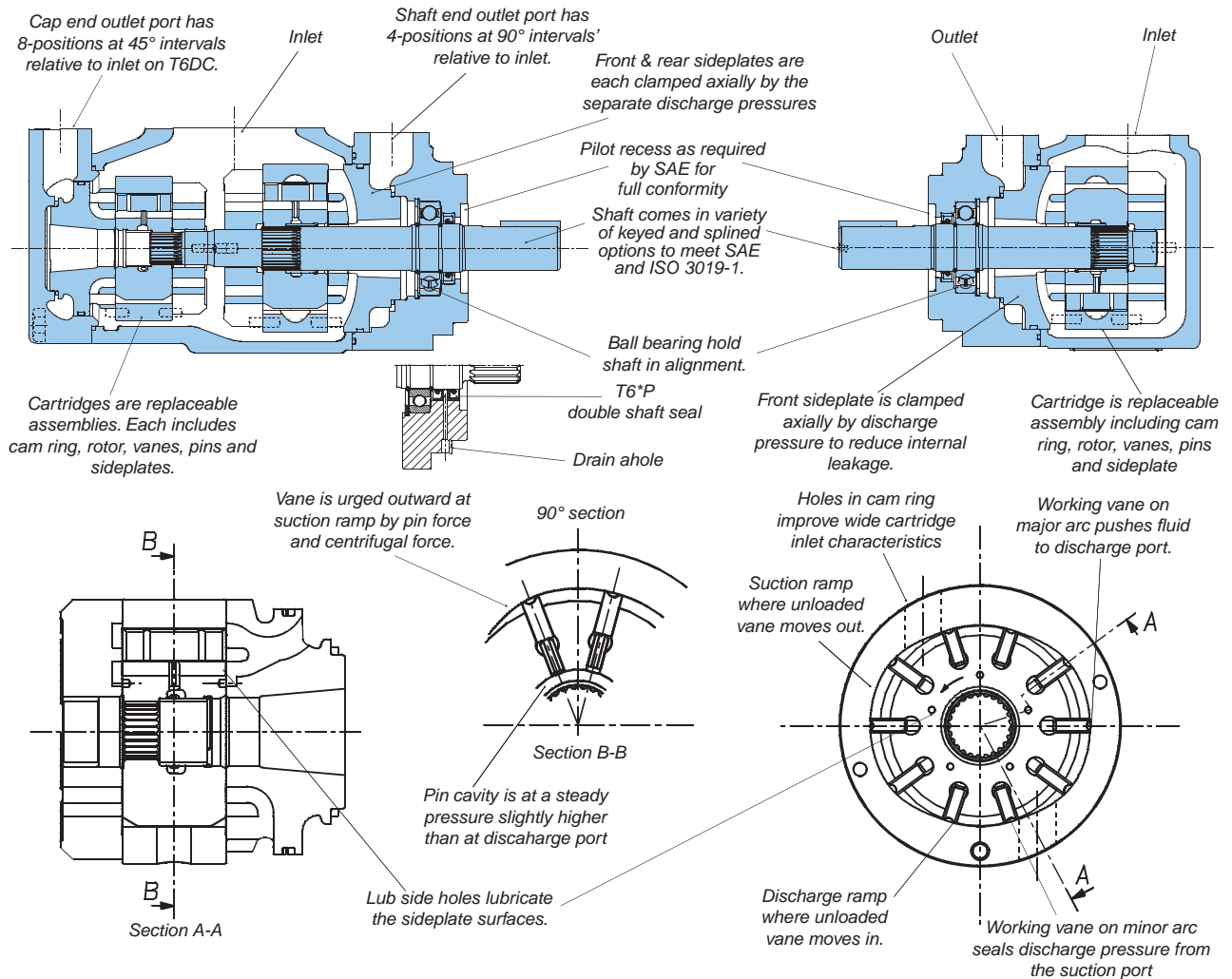

APPLICATION ADVANTAGES

- The high pressure capability to 275 bar, in the small envelope, reduces installation costs and provides extended life at reduced pressure.
- The high volumetric efficiency, typically 94%, reduces heat generation, and allows speeds down to 400 RPM at full pressure.
- The high mechanical efficiency, typically 94%, reduces energy consumption.
- The wide speed range from 400 RPM to 2800 RPM, combined with large size cartridge displacements, will optimize operation for the lowest noise level in the smallest envelope.
- The low speed 400 RPM, low pressure, high viscosity 2000 cSt allow application in cold environments with minimum energy consumption and without seizure risk.
- The low ripple pressure ± 2 bar reduces piping noise and increases life time of other components in the circuit.
- The high resistance to particle contamination because of the double lip vane increases pump life.
- The large variety of options (cam displacement, shaft, porting) allows customized installation.
- The shaft option T (SAE J718c), allows direct drive (at 540 or 1000 RPM) on tractors.
- The double shaft seal (T6*P version) and drain hole allow direct mounting onto gear boxes.

RECOMMENDED FLUIDS	<p>Petroleum based antiwear R & O fluids. These fluids are the recommended fluids for T6 series pumps. Maximum catalog ratings and performance data are based on operation with these fluids. These fluids are covered by DENISON fluid specifications HF-0 and HF-2.</p>															
ACCEPTABLE ALTERNATE FLUIDS	<p>The use of fluids other than petroleum based antiwear R & O fluids, requires that the maximum ratings of the pumps will be reduced. In some cases the minimum replenishment pressures must be increased. Consult specific sections for more details.</p>															
VISCOSITY	<table border="0"> <tr> <td>Max (cold start, low speed & pressure) _____</td> <td>2000</td> <td>mm²/s (cSt)</td> </tr> <tr> <td>Max (full speed & pressure) _____</td> <td>108</td> <td>mm²/s (cSt)</td> </tr> <tr> <td>Optimum (max. life) _____</td> <td>30</td> <td>mm²/s (cSt)</td> </tr> <tr> <td>Min (full speed & pressure for HF-1, HF-3, HF-4 & HF-5 fluids) _____</td> <td>18</td> <td>mm²/s (cSt)</td> </tr> <tr> <td>Min (full speed & pressure for HF-0 & HF-2 fluids) _____</td> <td>10</td> <td>mm²/s (cSt)</td> </tr> </table>	Max (cold start, low speed & pressure) _____	2000	mm ² /s (cSt)	Max (full speed & pressure) _____	108	mm ² /s (cSt)	Optimum (max. life) _____	30	mm ² /s (cSt)	Min (full speed & pressure for HF-1, HF-3, HF-4 & HF-5 fluids) _____	18	mm ² /s (cSt)	Min (full speed & pressure for HF-0 & HF-2 fluids) _____	10	mm ² /s (cSt)
Max (cold start, low speed & pressure) _____	2000	mm ² /s (cSt)														
Max (full speed & pressure) _____	108	mm ² /s (cSt)														
Optimum (max. life) _____	30	mm ² /s (cSt)														
Min (full speed & pressure for HF-1, HF-3, HF-4 & HF-5 fluids) _____	18	mm ² /s (cSt)														
Min (full speed & pressure for HF-0 & HF-2 fluids) _____	10	mm ² /s (cSt)														
VISCOSITY INDEX	<p>90° min. higher values extend range of operating temperatures. Maximum fluid temperature (θ) °C</p> <table border="0"> <tr> <td>HF-0, HF-1, HF-2 _____</td> <td>+ 100°</td> </tr> <tr> <td>HF-3, HF-4 _____</td> <td>+ 50°</td> </tr> <tr> <td>HF-5 _____</td> <td>+ 70°</td> </tr> <tr> <td>Biodegradable fluids (esters & rapeseed base) _____</td> <td>+ 65°</td> </tr> </table> <p>Minimum fluid temperature (θ) °C</p> <table border="0"> <tr> <td>HF-0, HF-1, HF-2, HF-5 _____</td> <td>- 18°</td> </tr> <tr> <td>HF-3, HF-4 _____</td> <td>+ 10°</td> </tr> <tr> <td>Biodegradable fluids (esters & rapeseed base) _____</td> <td>- 20°</td> </tr> </table>	HF-0, HF-1, HF-2 _____	+ 100°	HF-3, HF-4 _____	+ 50°	HF-5 _____	+ 70°	Biodegradable fluids (esters & rapeseed base) _____	+ 65°	HF-0, HF-1, HF-2, HF-5 _____	- 18°	HF-3, HF-4 _____	+ 10°	Biodegradable fluids (esters & rapeseed base) _____	- 20°	
HF-0, HF-1, HF-2 _____	+ 100°															
HF-3, HF-4 _____	+ 50°															
HF-5 _____	+ 70°															
Biodegradable fluids (esters & rapeseed base) _____	+ 65°															
HF-0, HF-1, HF-2, HF-5 _____	- 18°															
HF-3, HF-4 _____	+ 10°															
Biodegradable fluids (esters & rapeseed base) _____	- 20°															
FLUID CLEANLINESS	<p>The fluid must be cleaned before and during operation to maintain contamination level of NAS 1638 class 8 (or ISO 19/17/14) or better. Filters with 25 micron (or better β₁₀ ≥ 100) nominal ratings may be adequate but do not guarantee the required cleanliness levels. Suction strainers must be of adequate size to provide minimum inlet pressure specified. 100 mesh (149 micron) is the finest mesh recommended. Use oversize strainers or omit them altogether on applications which require cold starts or use fire resistant fluids.</p>															
OPERATING TEMPERATURES AND VISCOSITIES	<p>Operating temperatures are a function of fluid viscosities, fluid type, and the pump. Fluid viscosity should be selected to provide optimum viscosity at normal operating temperatures. For cold starts the pumps should be operated at low speed and pressure until fluid warms up to an acceptable viscosity for full power operation.</p>															
WATER CONTAMINATION IN THE FLUID	<p>Maximum acceptable content of water.</p> <ul style="list-style-type: none"> • 0,10 % for mineral base fluids. • 0,05 % for synthetic fluids, crankcase oils, biodegradable fluids. <p>If amount of water is higher, then it should be drained off the circuit.</p>															
COUPLINGS AND FEMALE SPLINES	<ul style="list-style-type: none"> • The mating female spline should be free to float and find its own center. If both members are rigidly supported, they must be aligned within 0,15 TIR or less to reduce fretting. The angular alignment of two spline axes must be less than ± 0,05 per 25,4 radius. • The coupling spline must be lubricated with a lithium molydisulfide grease or a similar lubricant. • The coupling must be hardened to a hardness between 27 and 45 R.C. • The female spline must be made to conform to the Class 1 fit as described in SAE-J498b (1971). This is described as a Flat Root Side Fit. 															
KEYED SHAFTS	<p>Parker supplies the T6 series keyed shaft pumps with high strength heat-treated keys. Therefore, when installing or replacing these pumps, the heat-treated keys must be used in order to insure maximum life in the application. If the key is replaced it must be a heat-treated key between 27 and 34 R.C. hardness. The corners of the keys must be chamfered from 0,76 to 1,02 at 45° to clear radii in the key way.</p>															
NOTE	<p>Alignment of keyed shafts must be within tolerances given for splined shafts.</p>															
SHAFT LOADS	<p>These products are designed primarily for coaxial drives which do not impose axial or side loading on the shaft. Consult specific sections for more details.</p>															

Model No. **T6CM - B22 - 1 R 00 - C 1**

Series M = Mobile 1 shaft seal

Cam ring

(Delivery at 0 bar & 1500 r.p.m.)

B03 = 16,2 l/min	B17 = 87,4 l/min
B05 = 25,8 l/min	B20 = 95,7 l/min
B06 = 31,9 l/min	B22 = 105,4 l/min
B08 = 39,6 l/min	B25 = 118,9 l/min
B10 = 51,1 l/min	B28 = 133,2 l/min
B12 = 55,6 l/min	B31 = 150,0 l/min
B14 = 69,0 l/min	

Type of shaft

- 1 = keyed (SAE B)
- 2 = keyed (no SAE)
- 3 = splined (SAE B)
- 4 = splined (SAE BB)

Modification

Seal class

- 1 = S1 (for mineral oil)
- 4 = S4 (for the resistant fluids)
- 5 = S5 (for mineral oil and fire resistant fluids)

Design letter

Porting combination

00 = standard

Direct. of rotation (view on shaft end)

- R = clockwise
- L = counter-clockwise

P = Pressure port

S = Suction port

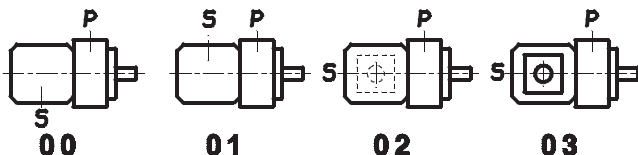

INTERNAL LEAKAGE (TYPICAL)

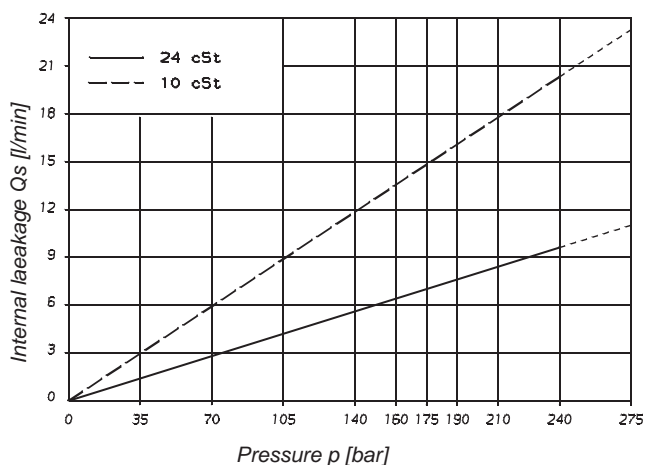

Do not operate the pump more than 5 seconds at any speed or viscosity if internal leakage is more than 50 % of theoretical flow.

NOISE LEVEL (TYPICAL)
T6CM - B22

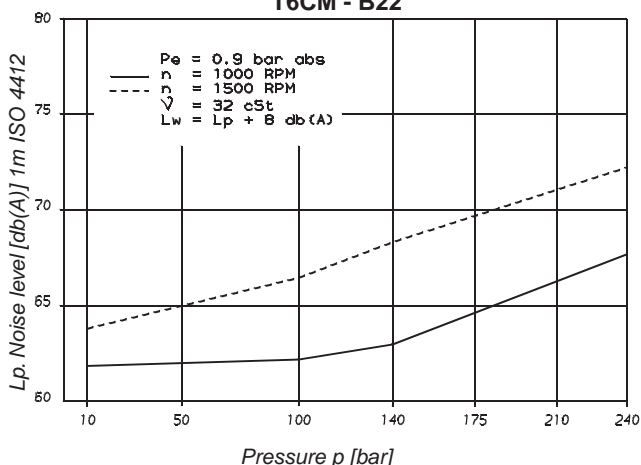

POWER LOSS HYDROMECHANICAL (TYPICAL)

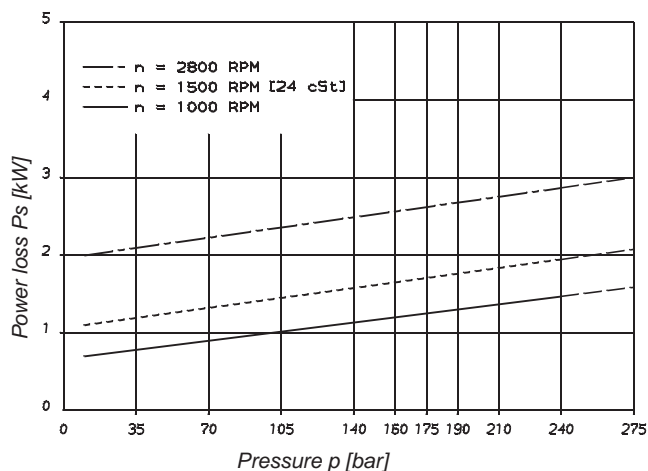

PERMISSIBLE RADIAL LOAD

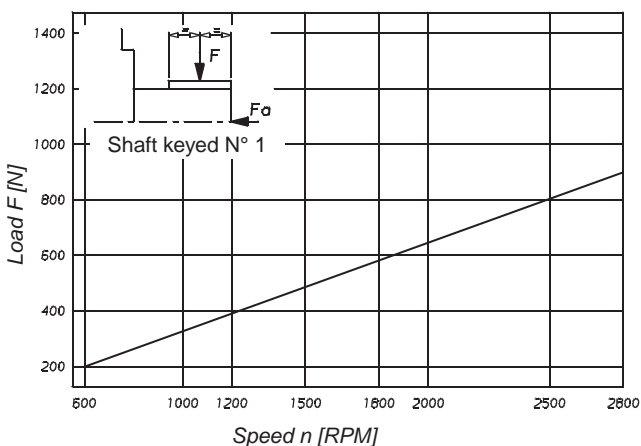

Maximum permissible axial load $F_a = 800\text{ N}$

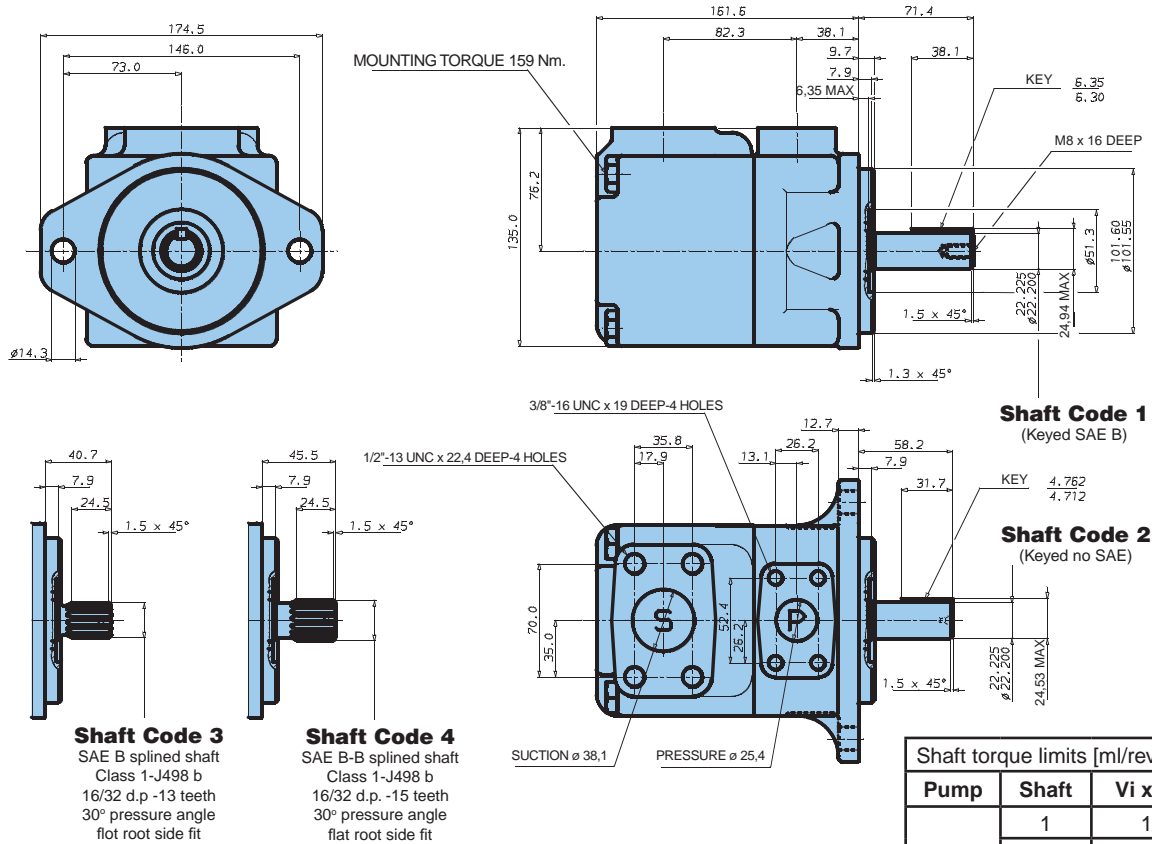

Shaft torque limits [ml/rev x bar]		
Pump	Shaft	Vi x p max.
T6CM	1	16500
	2	14300
	3	20600
	4	21800

OPERATING CHARACTERISTICS - TYPICAL [24 cSt]

Series	Volumetric Displacement Vi	Speed n [R.P.M.]	Flow Q [l/min]			Input power P [kW]		
			p = 0 bar	p = 140 bar	p = 240 bar	p = 7 bar	p = 140 bar	p = 240 bar
B03	10,8 ml/rev	1000	10,8	-	-	1,0	-	-
		1500	16,2	10,7	-	1,3	5,3	-
B05	17,2 ml/rev	1000	17,2	11,7	-	1,1	5,1	-
		1500	25,8	20,3	15,8	1,4	7,5	12,2
B06	21,3 ml/rev	1000	21,3	15,8	11,3	1,1	6,0	10,0
		1500	31,9	26,5	22,0	1,5	8,9	14,7
B08	26,4 ml/rev	1000	26,4	20,9	16,4	1,2	7,2	12,1
		1500	39,6	34,1	29,6	1,6	10,7	17,7
B10	34,1 ml/rev	1000	34,1	28,6	24,1	1,3	8,9	15,1
		1500	51,1	45,7	41,2	1,7	13,4	22,3
B12	37,1 ml/rev	1000	37,1	31,6	27,1	1,3	9,6	16,3
		1500	55,6	50,2	45,7	1,7	14,4	24,1
B14	46,0 ml/rev	1000	46,0	40,5	36,0	1,4	11,7	19,9
		1500	69,0	63,5	59,0	1,9	17,6	29,5
B17	58,3 ml/rev	1000	58,3	52,8	48,3	1,6	14,5	24,8
		1500	87,4	82,0	77,5	2,1	21,9	36,9
B20	63,8 ml/rev	1000	63,8	58,3	53,8	1,6	15,8	27,0
		1500	95,7	90,2	85,7	2,2	23,8	40,2
B22	70,3 ml/rev	1000	70,3	64,8	60,3	1,7	17,3	29,6
		1500	105,4	100,0	95,5	2,3	26,1	44,1
B25 ¹⁾	79,3 ml/rev	1000	79,3	73,8	69,3	1,8	19,3	33,2
		1500	118,9	113,5	109,0	2,5	29,2	49,5
B28 ¹⁾	88,8 ml/rev	1000	88,8	83,3	80,1 ²⁾	1,9	21,9	32,5 ²⁾
		1500	133,2	127,7	124,5 ²⁾	2,8	32,7	48,5 ²⁾
B31 ¹⁾	100,0 ml/rev	1000	100,0	94,5	91,3 ²⁾	2,0	24,4	36,4 ²⁾
		1500	150,0	144,5	141,3 ²⁾	2,8	36,5	54,4 ²⁾

¹⁾ B25 - B28 - B31 = 2500 R.P.M. max.

²⁾ B28 - B31 = 210 bar max. int.

- Not to use because internal leakage greater than 50% theoretical flow.

Port connection can be furnished with metric threads

Model No. T6CP - B22 - 2 R 00 - A 1

Series P = Mobile 2 shaft seals

Cam ring

(Delivery at 0 bar & 1500 r.p.m.)

B14 = 69,0 l/min B25 = 118,9 l/min

B17 = 87,4 l/min B28 = 133,2 l/min

B20 = 95,7 l/min B31 = 150,0 l/min

B22 = 105,4 l/min

Type of shaft

2 = keyed (no SAE)

3 = splined (SAE C)

Modification

Seal class

1 = S1 (for mineral oil)

4 = S4 (for the resistant fluids)

5 = S5 (for mineral oil and fire resistant fluids)

Design letter

Porting combination

00 = standard

Direct. of rotation (view on shaft end)

R = clockwise

L = counter-clockwise

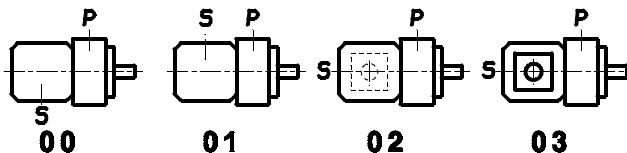

INTERNAL LEAKAGE (TYPICAL)

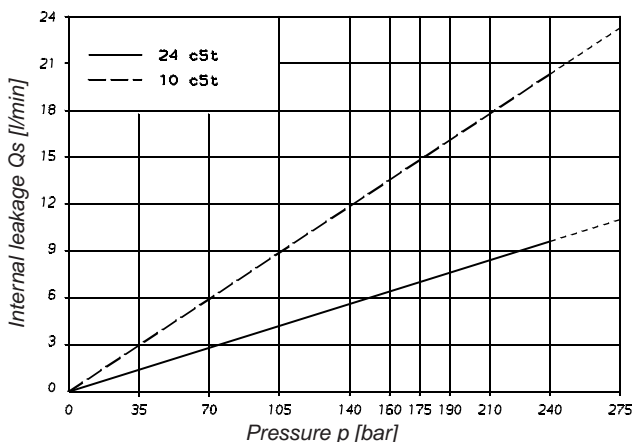

NOISE LEVEL (TYPICAL)
 T6CP - B22

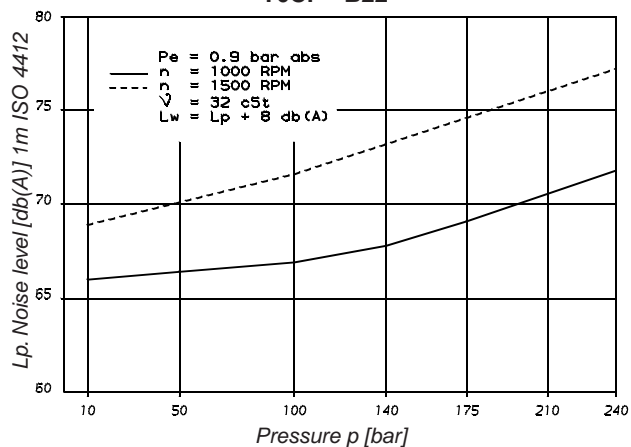

Do not operate the pump more than 5 seconds at any speed or viscosity if internal leakage is more than 50 % of theoretical flow.

POWER LOSS HYDROMECHANICAL (TYPICAL)

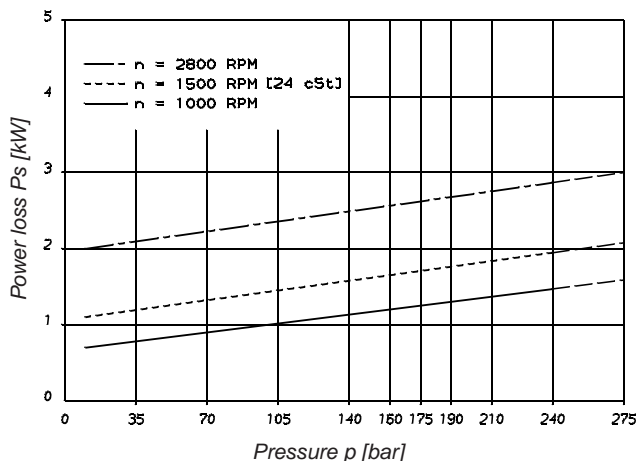

PERMISSIBLE RADIAL LOAD

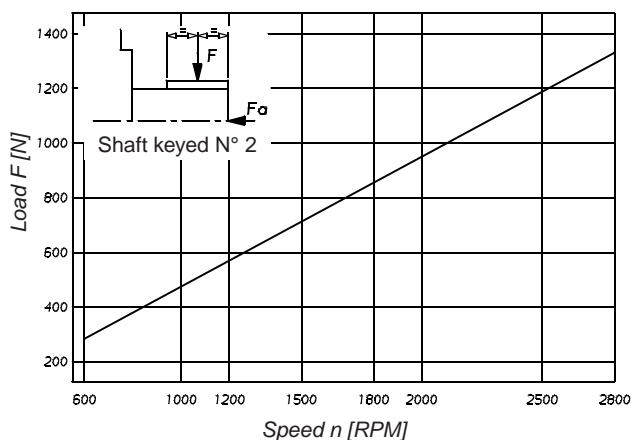

Maximum permissible axial load Fa = 800 N

Model No.

T6D* - B45 - 1 R 00 - C 1

Series M = Mobile 1 shaft seal
Series P = Mobile 2 shaft seals

Cam ring

(Delivery at 0 bar & 1500 r.p.m.)

- B14 = 71,4 l/min
- B17 = 87,3 l/min
- B20 = 99,0 l/min
- B24 = 119,3 l/min
- B28 = 134,5 l/min
- B31 = 147,4 l/min
- B35 = 166,5 l/min
- B38 = 180,4 l/min
- B42 = 204,0 l/min
- B45 = 218,5 l/min
- B50 = 237,0 l/min

Type of shaft

- M version**
- 1 = keyed (SAE C)
 - 2 = keyed (no SAE)
 - 3 = splined (SAE C)
 - 4 = splined (no SAE)
 - T = splined (SAE J718c)

Type of shaft

- P version**
- 3 = splined (no SAE)

Modification

Seal class

- 1 = S1 (for mineral oil)
- 4 = S4 (for the resistant fluids)
- 5 = S5 (for mineral oil and fire resistant fluids)

Design letter

Porting combination

00 = standard

Direct. of rotation (view on shaft end)

- R = clockwise
- L = counter-clockwise

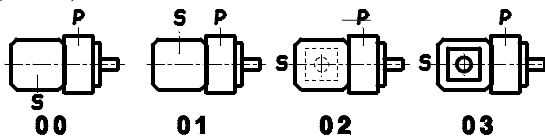

P = Pressure port
S = Suction port

INTERNAL LEAKAGE (TYPICAL)

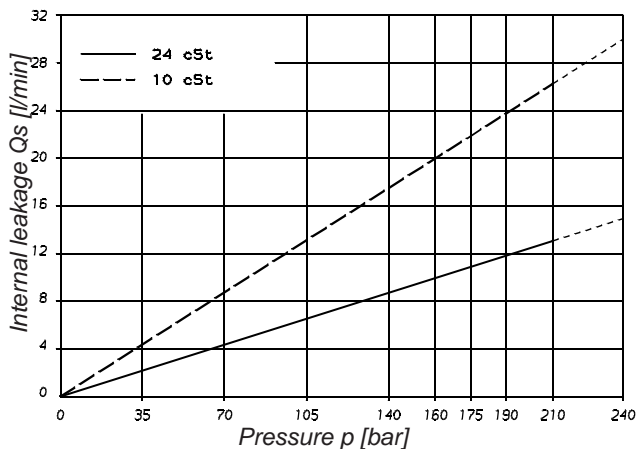

NOISE LEVEL (TYPICAL)
T6DM - B38

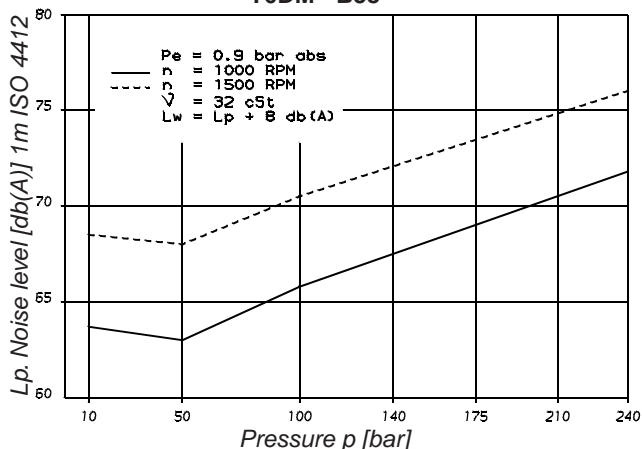

POWER LOSS HYDROMECHANICAL (TYPICAL)

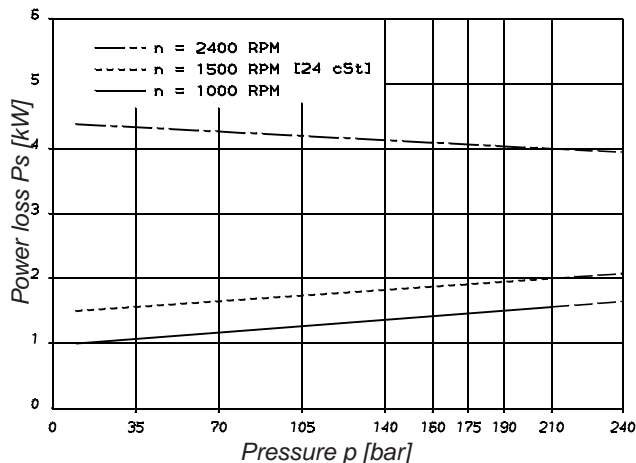

PERMISSIBLE RADIAL LOAD

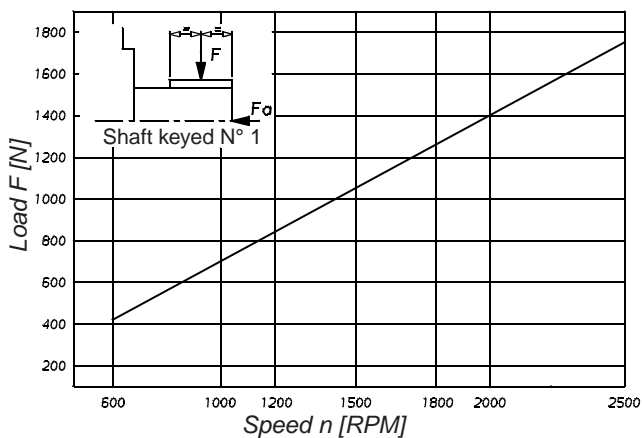

Maximum permissible axial load Fa = 1200 N

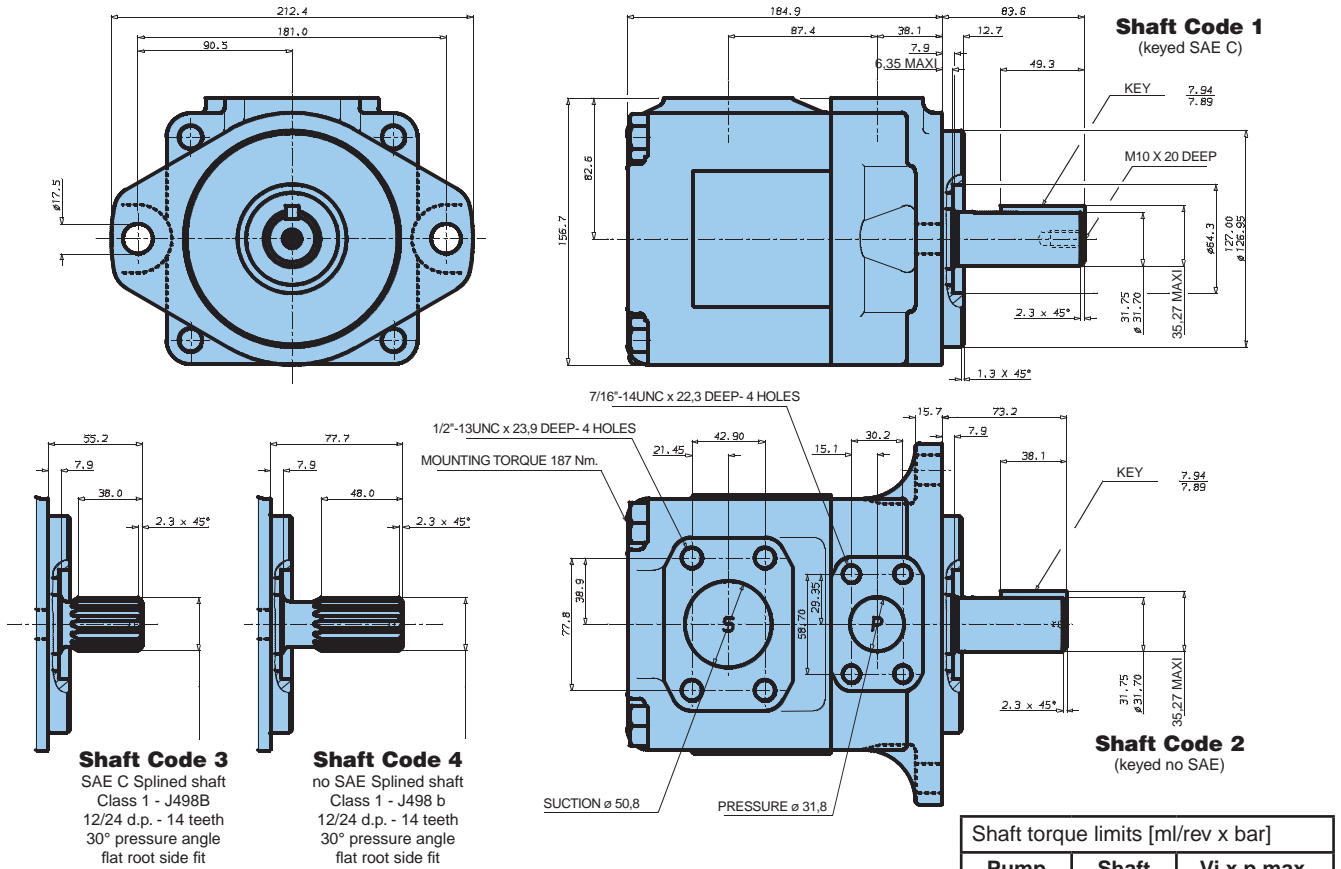

Additional T6DM shaft code T: see page 33
 Additional T6DP version shaft see page 33

OPERATING CHARACTERISTICS - TYPICAL [24 cSt]

Series	Volumetric Displacement Vi	Speed n [R.P.M.]	Flow Q [l/min]			Input power P [kW]		
			p = 0 bar	p = 140 bar	p = 240 bar	p = 7 bar	p = 140 bar	p = 240 bar
B14	47.6 ml/rev	1000	47.6	38.3	32.1	1.5	12.5	20.7
		1500	71.4	62.1	55.9	2.3	18.5	30.6
B17	58.2 ml/rev	1000	58.2	48.9	42.7	1.6	14.9	24.9
		1500	87.3	78.0	71.8	2.5	22.2	37.0
B20	66.0 ml/rev	1000	66.0	56.7	50.5	1.7	16.8	28.0
		1500	99.0	89.7	83.5	2.8	24.9	41.7
B24	79.5 ml/rev	1000	79.5	70.2	64.0	1.9	19.9	33.4
		1500	119.3	110.0	103.8	3.0	29.6	49.8
B28	89.7 ml/rev	1000	89.7	80.4	74.2	2.0	22.3	37.5
		1500	134.5	125.2	119.0	3.2	33.2	55.9
B31	98.3 ml/rev	1000	98.3	89.0	82.8	2.1	24.3	40.9
		1500	147.4	138.1	131.9	3.3	36.2	61.0
B35	111.0 ml/rev	1000	111.0	101.7	95.5	2.3	27.3	46.0
		1500	166.5	157.2	151.0	3.5	40.7	68.7
B38	120.3 ml/rev	1000	120.3	111.0	104.8	2.4	29.4	49.8
		1500	180.4	171.1	164.9	3.7	43.9	74.3
B42 ¹⁾	136.0 ml/rev	1000	136.0	126.7	120.5	2.6	33.1	56.0
		1500	204.0	194.7	188.5	4.0	49.4	83.7
B45 ¹⁾	145.7 ml/rev	1000	145.7	136.4	130.2	2.7	35.3	59.9
		1500	218.5	209.2	203.0	4.1	52.8	89.5
B50 ¹⁾	158.0 ml/rev	1000	158.0	148.7	145.0 ²⁾	2.8	38.2	56.8 ²⁾
		1500	237.0	227.7	224.0 ²⁾	4.4	57.0	85.0 ²⁾

¹⁾ B42 - B45 - B50 = 2200 R.P.M. max.

²⁾ B50 = 210 bar max. int.

Port connection can be furnished with metric threads.

Model No.

T6E* - 066 - 3 R 00 - B 1

Series M = Mobile 1 shaft seal
Series P = Mobile 2 shaft seals

Cam ring

(Delivery at 0 bar & 1500 r.p.m.)

042 = 198,5 l/min 062 = 295,0 l/min
 045 = 213,6 l/min 066 = 319,9 l/min
 050 = 237,7 l/min 072 = 340,6 l/min
 052 = 247,2 l/min

Type of shaft

M version

1 = keyed (SAE CC)
 2 = keyed (no SAE)
 3 = splined (SAE C)
 4 = splined (SAE CC)
 T = splined (SAE J718c)

Type of shaft

P version

3 = splined (no SAE)

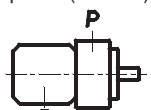

00

01

02

03

Modification

Seal class

1 = S1 (for mineral oil)
 4 = S4 (for the resistant fluids)
 5 = S5 (for mineral oil and fire resistant fluids)

Design letter

Porting combination

00 = standard

Direct. of rotation (view on shaft end)

R = clockwise

L = counter-clockwise

P = Pressure port

S = Suction port

INTERNAL LEAKAGE (TYPICAL)

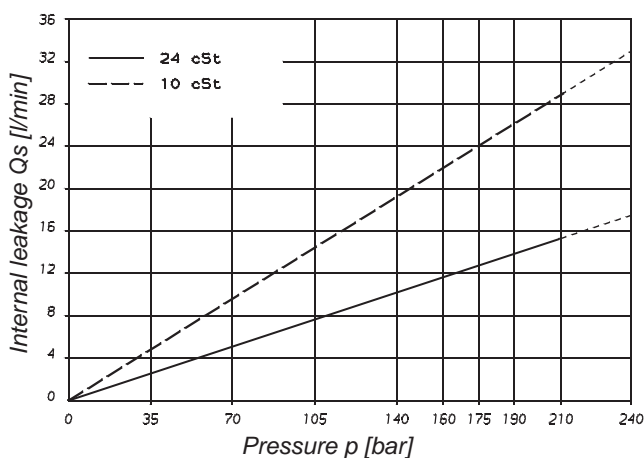

NOISE LEVEL (TYPICAL)
T6EM - 050

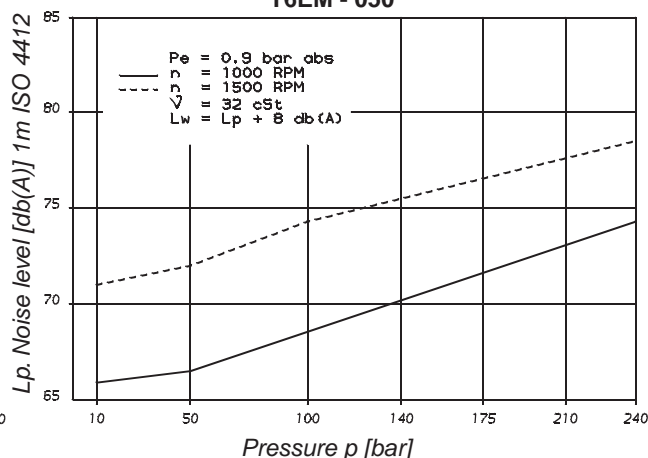

POWER LOSS HYDROMECHANICAL (TYPICAL)

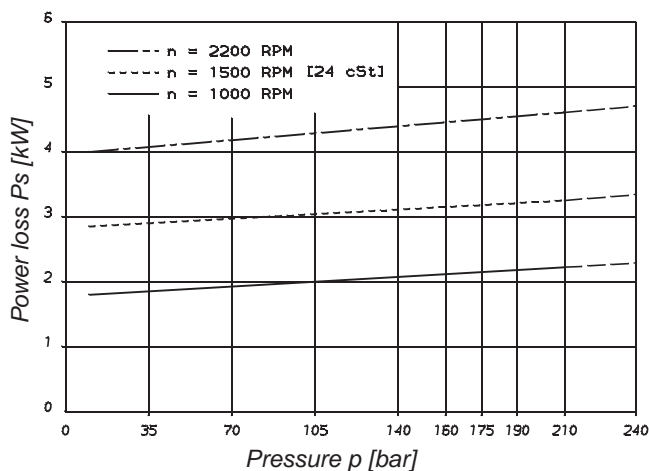

PERMISSIBLE RADIAL LOAD

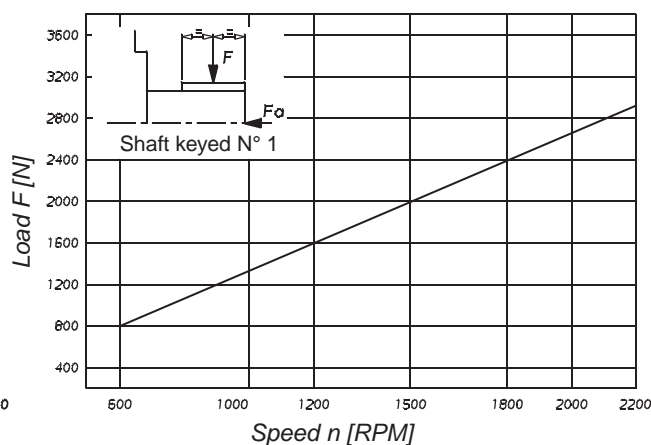

Maximum permissible axial load $F_a = 2000\text{ N}$

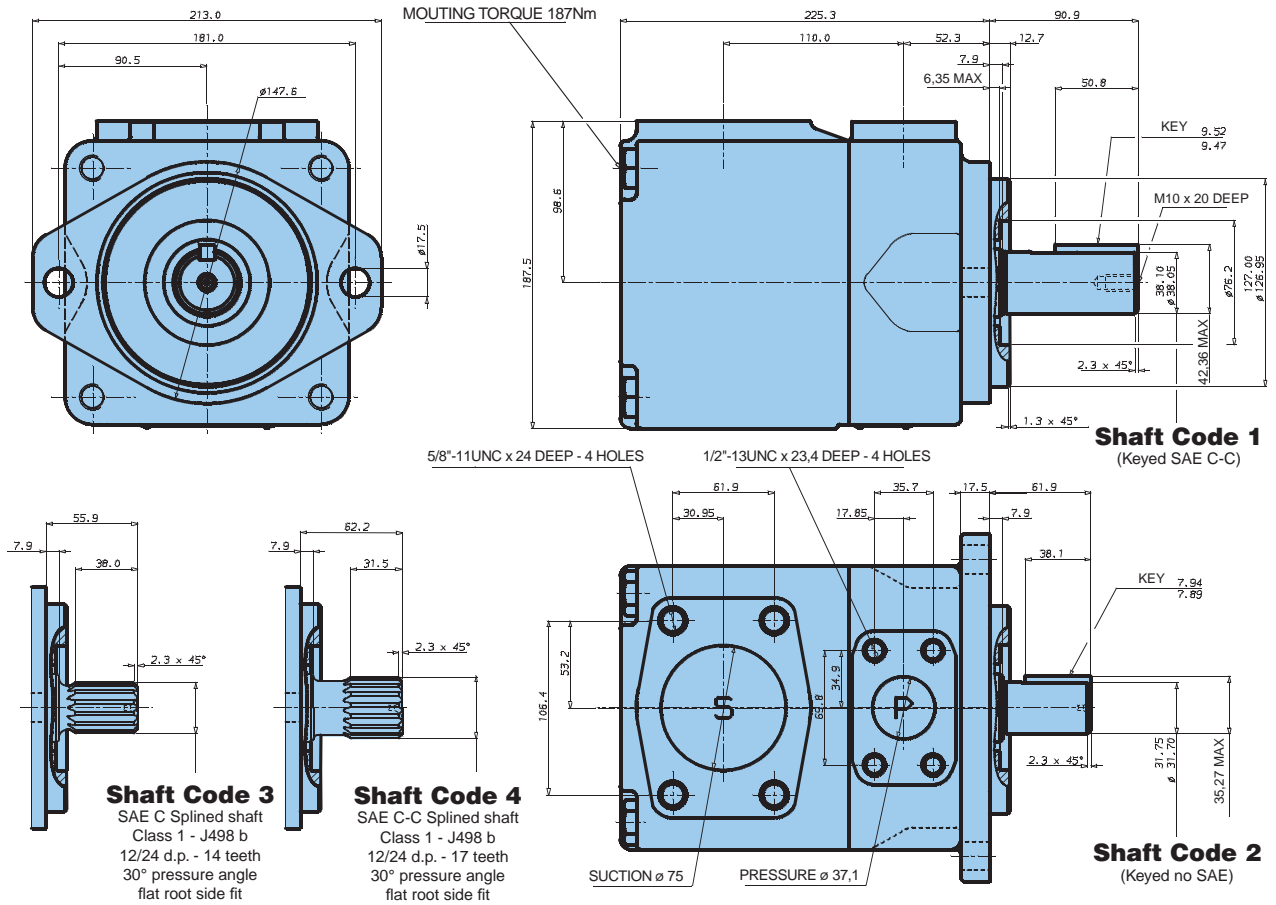

Additional T6EM shaft code T: see page 33
Additional T6EP version shaft see page 33

Shaft torque limits [ml/rev x bar]		
Pump	Shaft	Vi x p max.
T6EM	1	54500
	2	34590
	3	61200
	4	61200

OPERATING CHARACTERISTICS - TYPICAL [24 cSt]

Series	Volumetric Displacement Vi	Speed n [R.P.M.]	Flow Q [l/min]			Input power P [kW]		
			p = 0 bar	p = 140 bar	p = 240 bar	p = 7 bar	p = 140 bar	p = 240 bar
042	132,3 ml/rev	1000	132,3	122,3	115,2	3,2	32,9	55,2
		1500	198,5	188,5	181,3	5,2	49,4	82,6
045	142,4 ml/rev	1000	142,4	132,4	125,3	3,4	35,3	59,2
		1500	213,6	203,6	196,5	5,4	52,9	88,7
050	158,5 ml/rev	1000	158,5	148,5	141,4	3,5	39,0	65,6
		1500	237,7	227,7	220,6	5,7	58,5	98,3
052	164,8 ml/rev	1000	164,8	154,8	147,7	3,6	40,5	68,2
		1500	247,2	237,2	230,1	5,8	60,8	102,1
062	196,7 ml/rev	1000	196,7	186,7	179,6	4,0	47,9	80,9
		1500	295,0	285,0	277,9	6,4	71,9	121,3
066	213,3 ml/rev	1000	213,3	203,3	196,2	4,2	51,8	87,6
		1500	319,9	309,9	302,8	6,7	77,7	131,2
072	227,1 ml/rev	1000	227,1	217,1	210,0	4,3	55,0	93,1
		1500	340,6	330,6	323,5	6,9	82,6	139,5

Port connection can be furnished with metric threads.

Ordering Code

Model No.

T6CC* W - B22 - B08 - 1 R 00 - D 1-00

Series M = Mobile 1 shaft seal

Series P = Mobile 2 shaft seals

Use for severe duty shaft only*

Cam ring for "P1" & "P2"

(Delivery at 0 bar & 1500 r.p.m.)

B03 = 16,2 l/min B17 = 87,4 l/min

B05 = 25,8 l/min B20 = 95,7 l/min

B06 = 31,9 l/min B22 = 105,4 l/min

B08 = 39,6 l/min B25 = 118,9 l/min

B10 = 51,1 l/min B28 = 133,2 l/min

B12 = 55,6 l/min B31 = 150,0 l/min

B14 = 69,0 l/min

Type of shaft Type of shaft

M version

1 = keyed (no SAE)

3 = splined (SAE BB)

5 = splined (SAE B)

P version

3 = splined (no SAE)

4 = splined (SAE BB)

6 = splined (no SAE)

MW severe duty

*2 = keyed (SAE BB)

*R = keyed special

*X = keyed special

*W = keyed special

*V = keyed special

*T = splined (SAE J718c)

Modification

Mounting W/connection variables

	P1 = 1" - S = 3"		P1 = 1" - S = 2.1/2"²)	
P2	1"	3/4"¹)	1"	3/4"¹)
Code	00	01	10	11

¹) for 46 ml/rev. max.

²) for 126 ml/rev. max.

The largest cartridge must be always mounted in the front.

Seal Class

1 = S1 (for mineral oil)

4 = S4 (for the resistant fluids)

5 = S5 (for mineral oil and fire resistant fluids)

Design letter

Porting combination (see page 34)

00 = standard

Direct. of rotation (view on shaft end)

R = clockwise

L = counter-clockwise

INTERNAL LEAKAGE (TYPICAL)

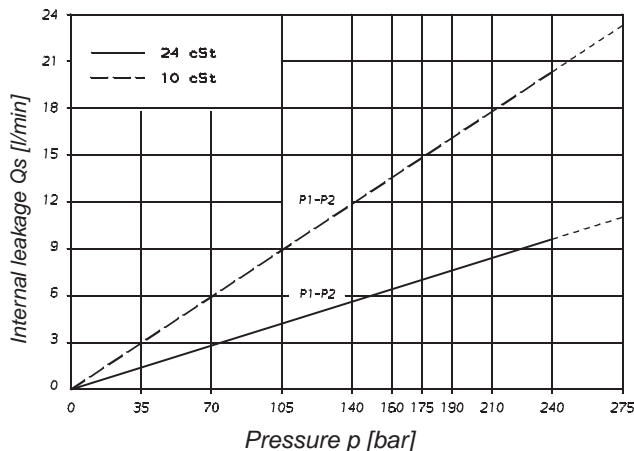

Do not operate the pump more than 5 seconds at any speed or viscosity if internal leakage is more than 50 % of theoretical flow. Total leakage is the sum of each section loss at its operating conditions.

**NOISE LEVEL (TYPICAL)
T6CCM - B22 - B22**

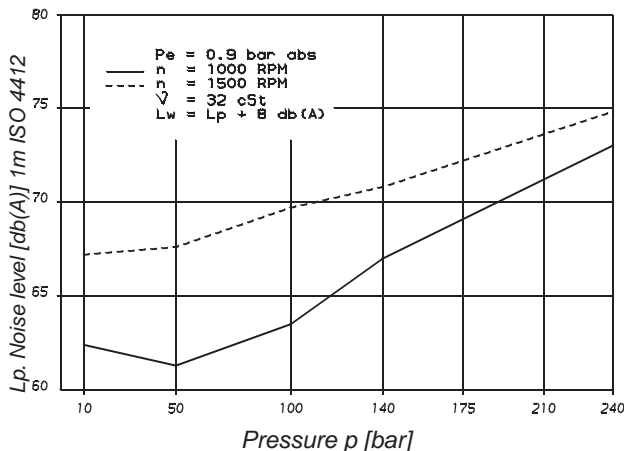

Double pump noise level is given with each section discharging at the pressure noted on the curve.

POWER LOSS HYDROMECHANICAL (TYPICAL)

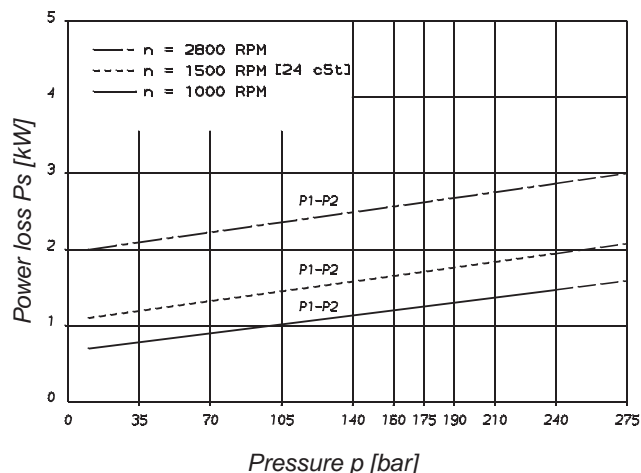

Total hydrodynamic power loss is the sum of each section at its operating conditions.

PERMISSIBLE RADIAL LOAD

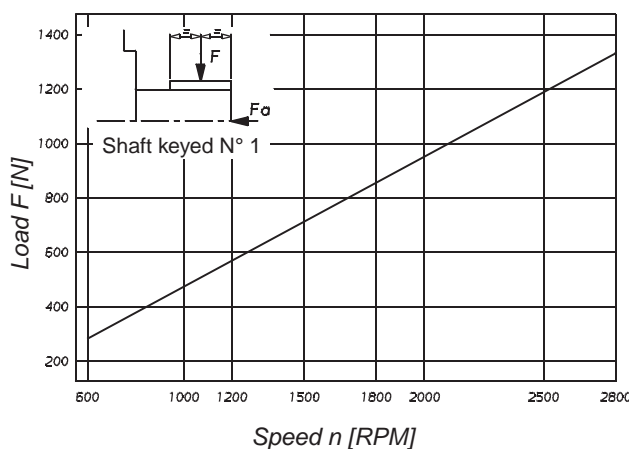

Maximum permissible axial load Fa = 800 N

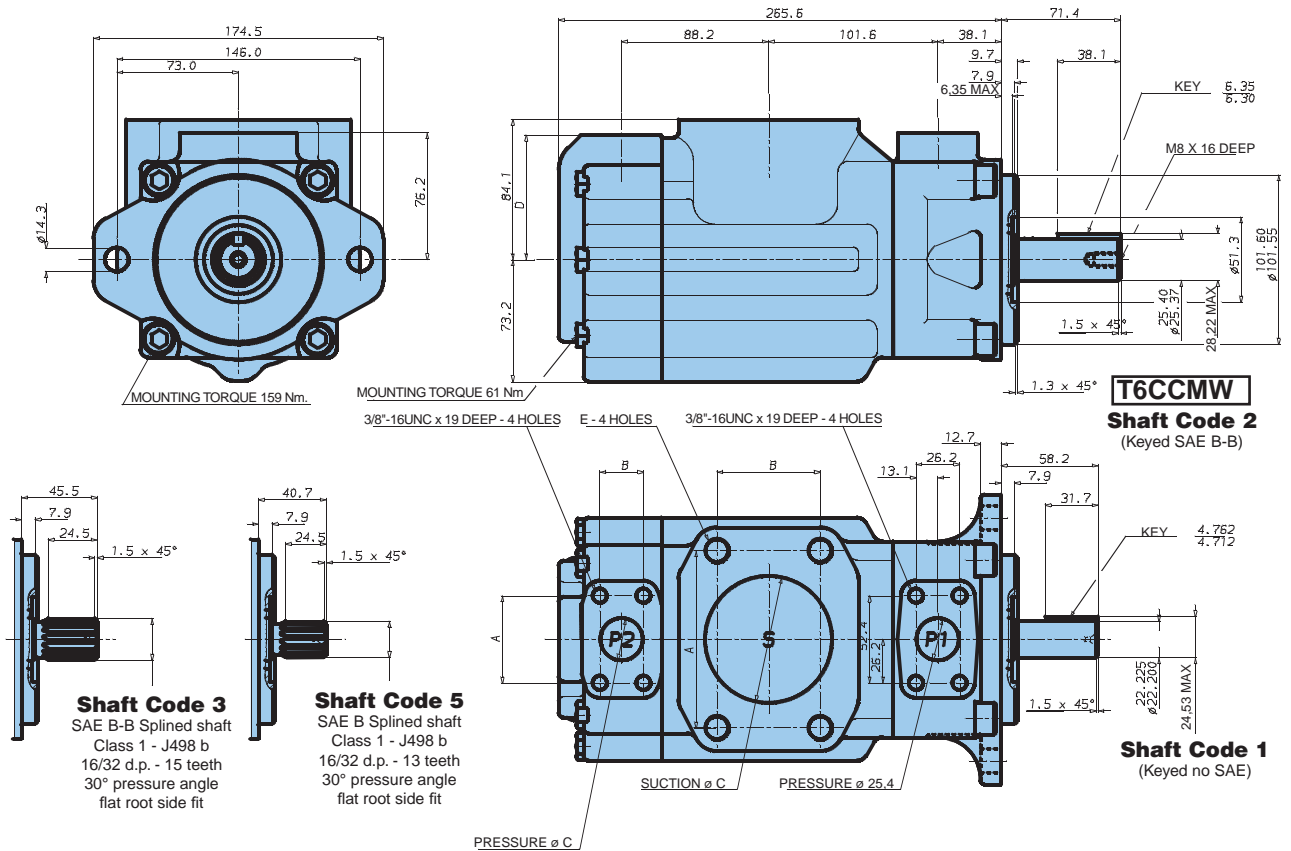

Additional special shafts: see page 33
 Additional T6CCMW shaft code T: see page 33
 Additional T6CCP version shaft see page 33

Port	Code	A	B	C	D	E
S	3"	106,4	61,9	76,2		5/8"-11 x 28.4 deep
S	2 1/2"	88,9	50,8	63,5		1/2"-13 x 23.9 deep
P1	1"	52,4	26,2	25,4	76,2	
P2	3/4"	47,7	22,2	19,0	76,2	
P2	1"	52,4	26,2	25,4	74,7	

Shaft torque limits [ml/rev x bar]		
Pump	Shaft	Vi x p max. P1 + P2
T6CCM	1	14300
T6CCMW	2	21420
T6CCM	3	32670
T6CCM	5	20600

OPERATING CHARACTERISTICS - TYPICAL [24 cSt]

Pressure port	Series	Volumetric Displacement Vi	Flow Q [l/min] & n = 1500 RPM			Input power P [kW] & n = 1500 RPM		
			p = 0 bar	p = 140 bar	p = 240 bar	p = 7 bar	p = 140 bar	p = 240 bar
P1 & P2	B03	10,8 ml/rev	16,2	10,7	-	1,3	5,3	-
	B05	17,2 ml/rev	25,8	20,3	15,8	1,4	7,5	12,2
	B06	21,3 ml/rev	31,9	26,5	22,0	1,5	8,9	14,7
	B08	26,4 ml/rev	39,6	34,1	29,6	1,6	10,7	17,7
	B10	34,1 ml/rev	51,1	45,7	41,2	1,7	13,4	22,3
	B12	37,1 ml/rev	55,6	50,2	45,7	1,7	14,4	24,1
	B14	46,0 ml/rev	69,0	63,5	59,0	1,9	17,6	29,5
	B17	58,3 ml/rev	87,4	82,0	77,5	2,1	21,9	36,9
	B20	63,8 ml/rev	95,7	90,2	85,7	2,2	23,8	40,2
	B22	70,3 ml/rev	105,4	100,0	95,5	2,3	26,1	44,1
	B25 ¹⁾	79,3 ml/rev	118,9	113,5	109,0	2,5	29,2	49,5
	B28 ¹⁾	88,8 ml/rev	133,2	127,7	124,5 ²⁾	2,8	32,7	48,5 ²⁾
	B31 ¹⁾	100,0 ml/rev	15,0	144,5	141,3 ²⁾	2,8	36,5	54,4 ²⁾

¹⁾ B25 - B28 - B31 = 2500 R.P.M. max. ²⁾ B28 - B31 = 210 bar max. int.
 - Not to use because internal leakage greater than 50% theoretical flow.

Port connection can be furnished with metric threads.

Ordering Code

Model No.

T6DC* W - B38 - B22 - 1 R 00 - C 1

Series M = Mobile 1 shaft seal
Series P = Mobile 2 shaft seals
Use for severe duty shaft only*

Cam ring for "P1"

(Delivery at 0 bar & 1500 r.p.m.)

B14 = 71,4 l/min	B35 = 166,5 l/min
B17 = 87,3 l/min	B38 = 180,4 l/min
B20 = 99,0 l/min	B42 = 204,0 l/min
B24 = 119,3 l/min	B45 = 218,5 l/min
B28 = 134,5 l/min	B50 = 237,0 l/min
B31 = 147,4 l/min	

Cam ring for "P2"

(Delivery at 0 bar & 1500 r.p.m.)

B03 = 16,2 l/min	B17 = 87,4 l/min
B05 = 25,8 l/min	B20 = 95,7 l/min
B06 = 31,9 l/min	B22 = 105,4 l/min
B08 = 39,6 l/min	B25 = 118,9 l/min
B10 = 51,1 l/min	B28 = 133,2 l/min
B12 = 55,6 l/min	B31 = 150,0 l/min
B14 = 69,0 l/min	

Modification

Seal Class

- 1 = S1 (for mineral oil)
- 4 = S4 (for the resistant fluids)
- 5 = S5 (for mineral oil and fire resistant fluids)

Design letter

Porting combination (see page 34)

00 = standard

Direct. of rotation (view on shaft end)

- R = clockwise
- L = counter-clockwise

Type of shaft

- P version
- 3 = splined (no SAE)

Type of shaft

M version

- 1 = keyed (SAE C)
- 2 = keyed (no SAE)
- 3 = splined (SAE C)
- 4 = splined (no SAE)

MW severe duty

- *5 = keyed (no SAE)
- *T = splined (SAE J718c)

INTERNAL LEAKAGE (TYPICAL)

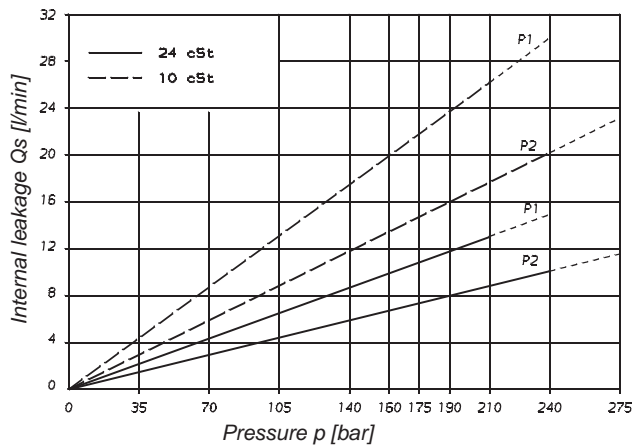

Do not operate the pump more than 5 seconds at any speed or viscosity if internal leakage is more than 50 % of theoretical flow. Total leakage is the sum of each section loss at its operating conditions.

NOISE LEVEL (TYPICAL)
T6DCM - B38 - B22

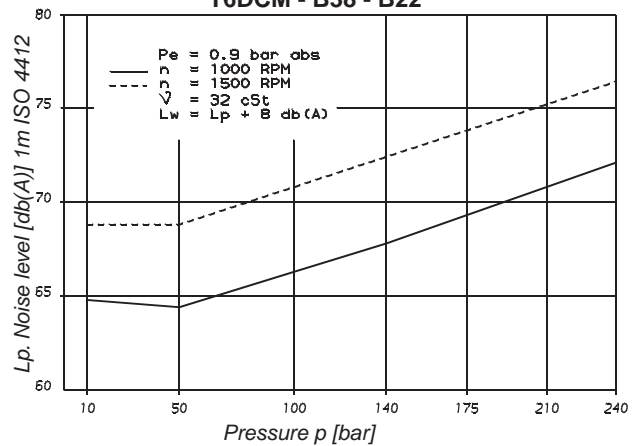

Double pump noise level is given with each section discharging at the pressure noted on the curve.

POWER LOSS HYDROMECHANICAL (TYPICAL)

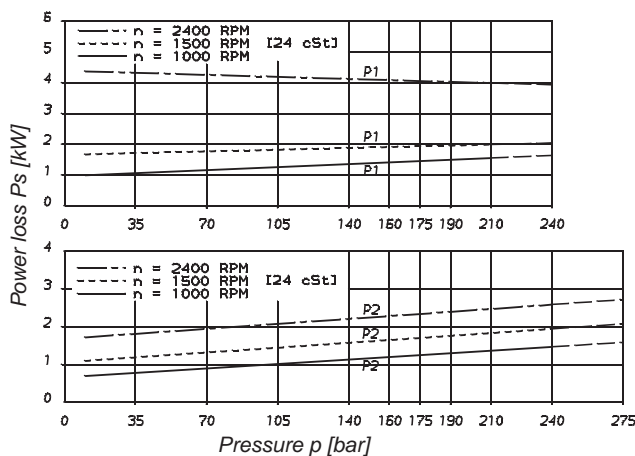

Total hydrodynamic power loss is the sum of each section at its operating conditions.

PERMISSIBLE RADIAL LOAD

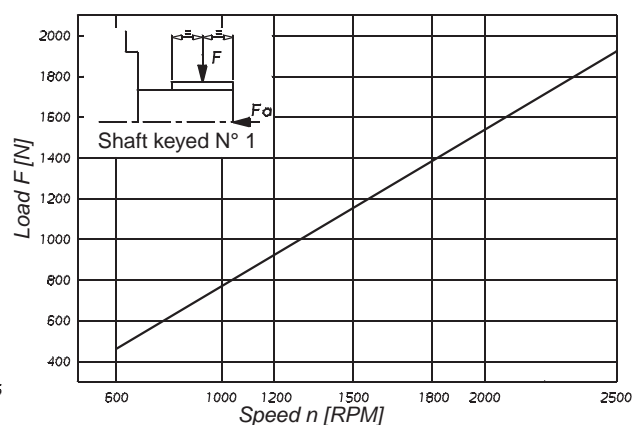

Maximum permissible axial load Fa = 1200 N

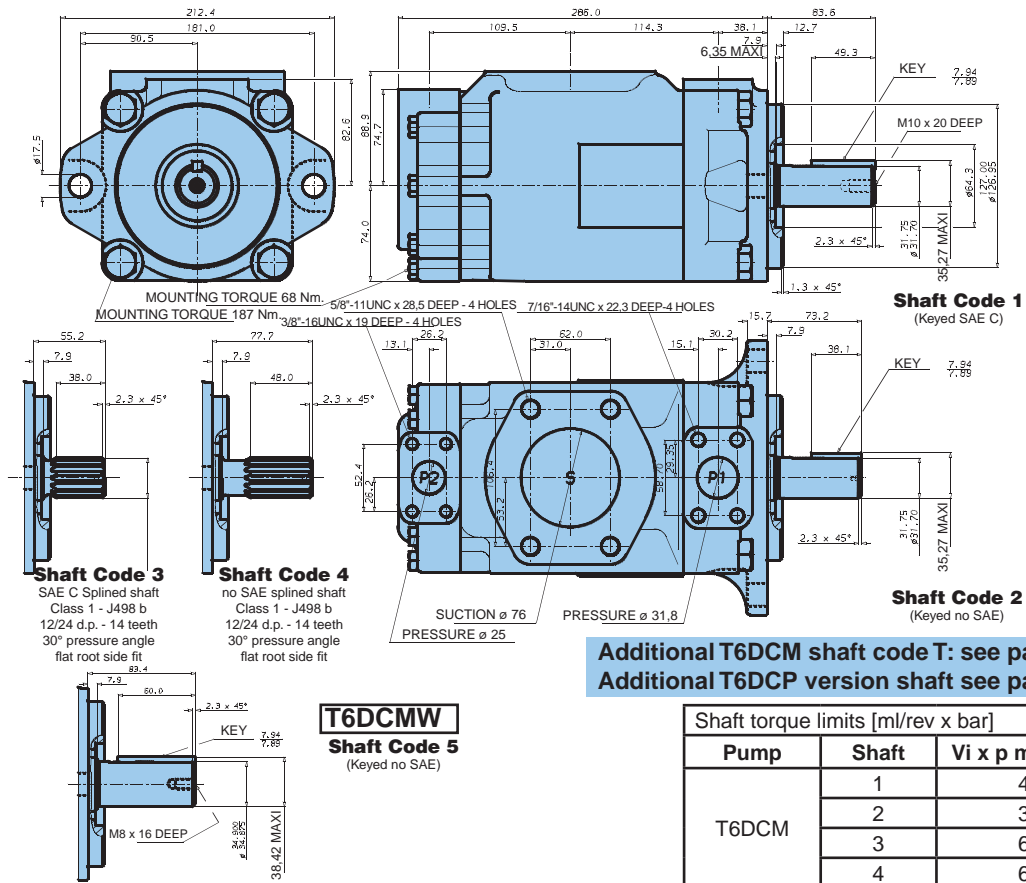

OPERATING CHARACTERISTICS - TYPICAL [24 cSt]

Pressure port	Series	Volumetric Displacement Vi	Flow Q [l/min] & n = 1500 RPM			Input power P [kW] & n = 1500 RPM		
			p = 0 bar	p = 140 bar	p = 240 bar	p = 7 bar	p = 140 bar	p = 240 bar
P1	B14	47,6 ml/rev	71,4	62,1	55,9	2,3	18,5	30,6
	B17	58,2 ml/rev	87,3	78,0	71,8	2,5	22,2	37,0
	B20	66,0 ml/rev	99,0	89,7	83,5	2,8	24,9	41,7
	B24	79,5 ml/rev	119,3	110,0	103,8	3,0	29,6	49,8
	B28	89,7 ml/rev	134,5	125,2	119,0	3,2	33,2	55,9
	B31	98,3 ml/rev	147,4	138,1	131,9	3,3	36,2	61,0
	B35	111,0 ml/rev	166,5	157,2	151,0	3,5	40,7	68,7
	B38	120,3 ml/rev	180,4	171,1	164,9	3,7	43,9	74,3
	B42 ²⁾	136,0 ml/rev	204,0	194,7	188,5	4,0	49,4	83,7
	B45 ²⁾	145,7 ml/rev	218,5	209,2	203,0	4,1	52,8	89,5
B50 ²⁾	158,0 ml/rev	237,0	227,7	224,0 ¹⁾	4,4	57,0	85,0 ¹⁾	
P2	B03	10,8 ml/rev	16,2	10,7	-	1,3	5,3	-
	B05	17,2 ml/rev	25,8	20,3	15,8	1,4	7,5	12,2
	B06	21,3 ml/rev	31,9	26,5	22,0	1,5	8,9	14,7
	B08	26,4 ml/rev	39,6	34,1	29,6	1,6	10,7	17,7
	B10	34,1 ml/rev	51,1	45,7	41,2	1,7	13,4	22,3
	B12	37,1 ml/rev	55,6	50,2	45,7	1,7	14,4	24,1
	B14	46,0 ml/rev	69,0	63,5	59,0	1,9	17,6	29,5
	B17	58,3 ml/rev	87,4	82,0	77,5	2,1	21,9	36,9
	B20	63,8 ml/rev	95,7	90,2	85,7	2,2	23,8	40,2
	B22	70,3 ml/rev	105,4	100,0	95,5	2,3	26,1	44,1
	B25	79,3 ml/rev	118,9	113,5	109,0	2,5	29,2	49,5
	B28	88,8 ml/rev	133,2	127,7	124,5 ¹⁾	2,8	32,7	48,5 ¹⁾
	B31	100,0 ml/rev	150,0	144,5	141,3 ¹⁾	2,8	36,5	54,4 ¹⁾

¹⁾ B28 - B31 - B50 = 210 bar max. int. ²⁾ B42 - B45 - B50 = 2200 R.P.M. max

- Not to use because internal leakage greater than 50% theoretical flow

Port connection can be furnished with metric threads.

Model No.

T6EC* - 066 - B22 - 1 R 00 - C 1 -

Series M = Mobile 1 shaft seal
Series P = Mobile 2 shaft seals

Cam ring for "P1"

(Delivery at 0 bar & 1500 r.p.m.)

042 = 198,5 l/min 062 = 295,0 l/min
 045 = 213,6 l/min 066 = 319,9 l/min
 050 = 237,7 l/min 072 = 340,6 l/min
 052 = 247,2 l/min

Cam ring for "P2"

(Delivery at 0 bar & 1500 r.p.m.)

B03 = 16,2 l/min B17 = 87,4 l/min
 B05 = 25,8 l/min B20 = 95,7 l/min
 B06 = 31,9 l/min B22 = 105,4 l/min
 B08 = 39,6 l/min B25 = 118,9 l/min
 B10 = 51,1 l/min B28 = 133,2 l/min
 B12 = 55,6 l/min B31 = 150,0 l/min
 B14 = 69,0 l/min

Modification

Seal Class

1 = S1 (for mineral oil)
 4 = S4 (for the resistant fluids)
 5 = S5 (for mineral oil and fire resistant fluids)

Design letter

Porting combination (see page 34)

00 = standard

Direct. of rotation (view on shaft end)

R = clockwise
 L = counter-clockwise

Type of shaft

P version
 3 = splined (non SAE)

Type of shaft

M version
 1 = keyed (SAE CC)
 2 = keyed (no SAE)
 3 = splined (SAE C)
 4 = splined (SAE CC)
 T = splined (SAE J718c)

INTERNAL LEAKAGE (TYPICAL)

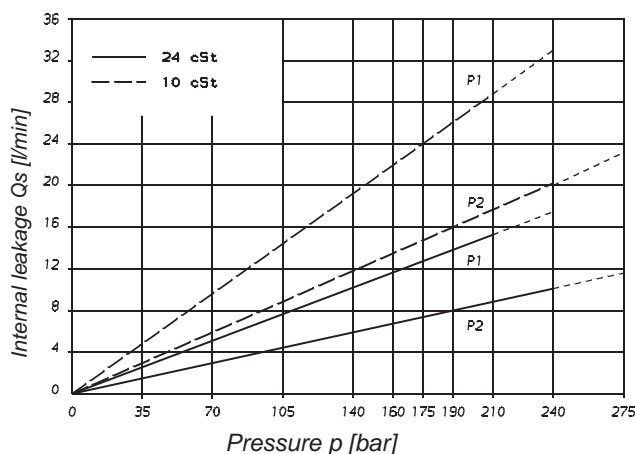

Do not operate the pump more than 5 seconds at any speed or viscosity if internal leakage is more than 50% of theoretical flow. Total leakage is the sum of each section loss at its operating conditions.

NOISE LEVEL (TYPICAL)

T6ECM - 050 - B22

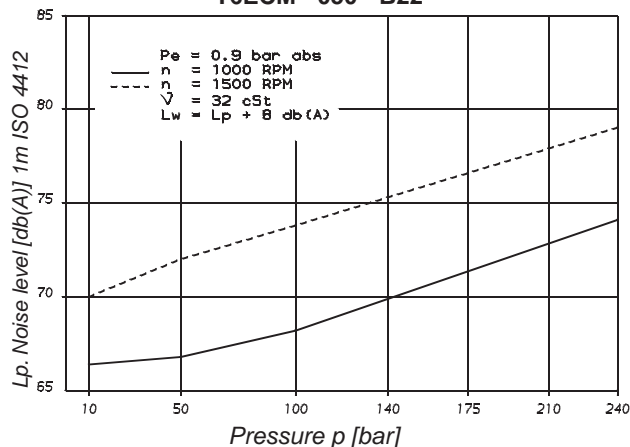

Double pump noise level is given with each section discharging at the pressure noted on the curve.

POWER LOSS HYDROMECHANICAL (TYPICAL)

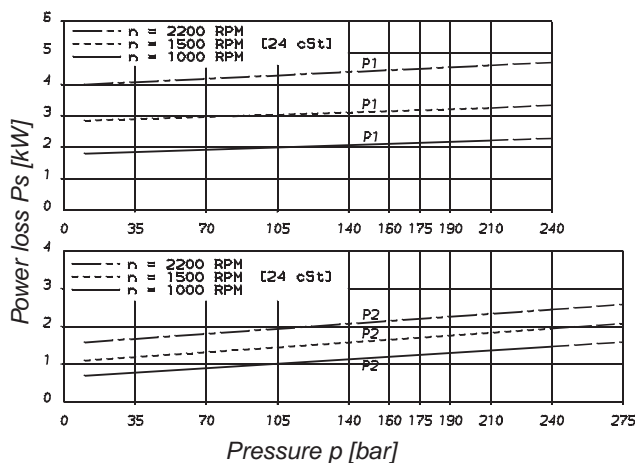

Total hydrodynamic power loss is the sum of each section at its operating conditions.

PERMISSIBLE RADIAL LOAD

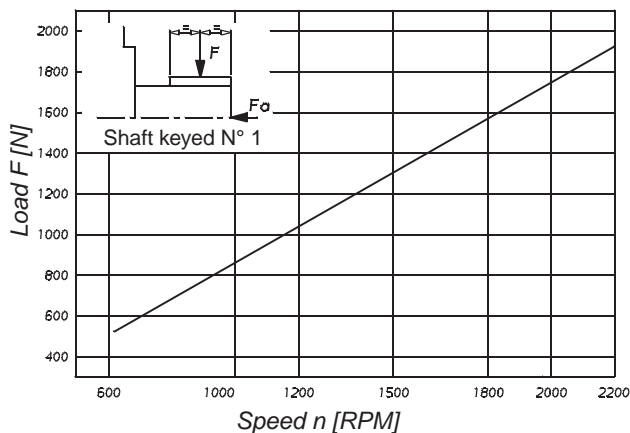

Maximum permissible axial load Fa = 2000 N

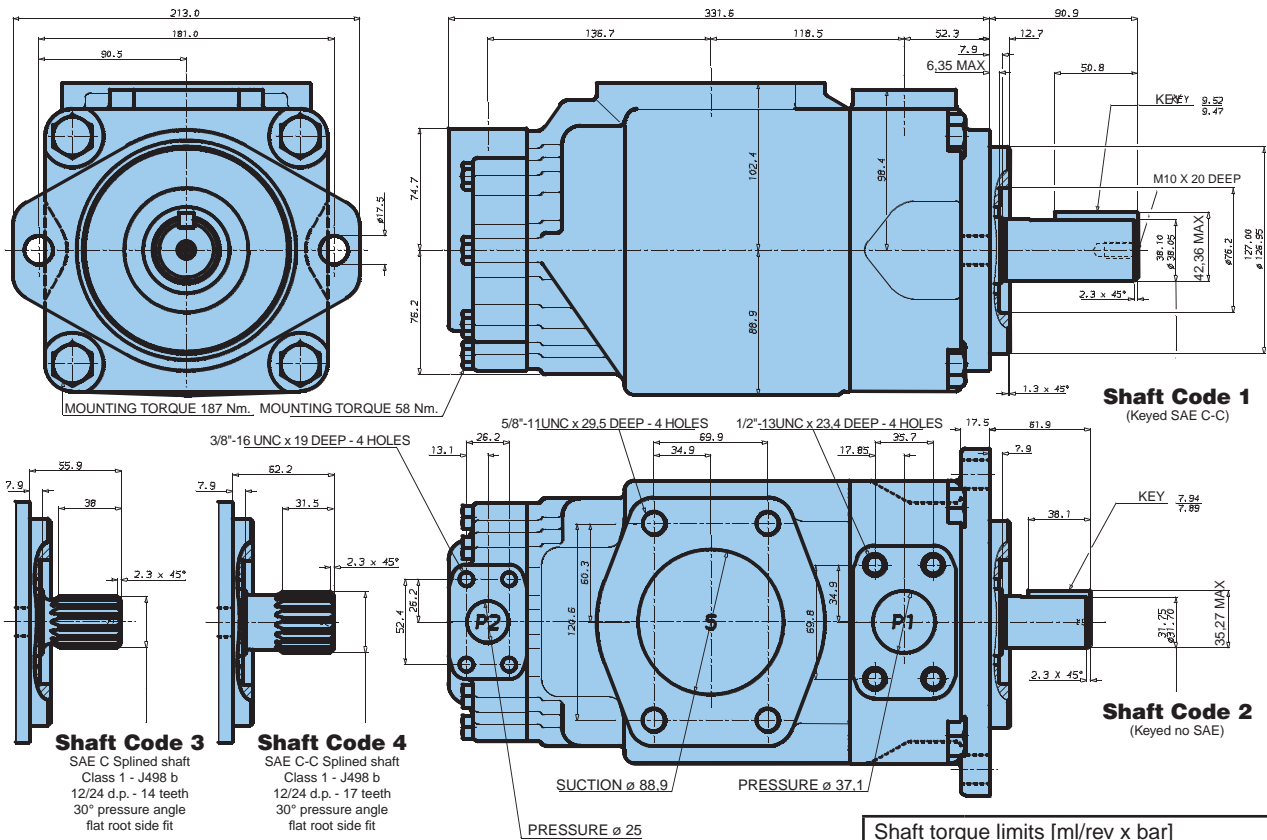

Additional T6ECM shaft code T: see page 33
Additional T6ECP version shaft see page 33

Shaft torque limits [ml/rev x bar]		
Pump	Shaft	Vi x p max. P1 + P2
T6ECM	1	72300
	2	34590
	3	61200
	4	76300

OPERATING CHARACTERISTICS - TYPICAL [24 cSt]

Pressure port	Series	Volumetric Displacement Vi	Flow Q [l/min] & n = 1500 RPM			Input power P [kW] & n = 1500 RPM		
			p = 0 bar	p = 140 bar	p = 240 bar	p = 7 bar	p = 140 bar	p = 240 bar
P1	042	132,3 ml/rev	198,5	188,5	181,3	5,2	49,4	82,6
	045	142,4 ml/rev	213,6	203,6	196,5	5,4	52,9	88,7
	050	158,5 ml/rev	237,7	227,7	220,6	5,7	58,5	98,3
	052	164,8 ml/rev	247,2	237,2	230,1	5,8	60,8	102,1
	062	196,7 ml/rev	295,0	285,0	277,9	6,4	71,9	121,3
	066	213,3 ml/rev	319,9	309,9	302,8	6,7	77,7	131,2
	072	227,1 ml/rev	340,6	330,6	323,5	6,9	82,6	139,5
P2	B03	10,8 ml/rev	16,2	10,7	-	1,3	5,3	-
	B05	17,2 ml/rev	25,8	20,3	15,8	1,4	7,5	12,2
	B06	21,3 ml/rev	31,9	26,5	22,0	1,5	8,9	14,7
	B08	26,4 ml/rev	39,6	34,1	29,6	1,6	10,7	17,7
	B10	34,1 ml/rev	51,1	45,7	41,2	1,7	13,4	22,3
	B12	37,1 ml/rev	55,6	50,2	45,7	1,7	14,4	24,1
	B14	46,0 ml/rev	69,0	63,5	59,0	1,9	17,6	29,5
	B17	58,3 ml/rev	87,4	82,0	77,5	2,1	21,9	36,9
	B20	63,8 ml/rev	95,7	90,2	85,7	2,2	23,8	40,2
	B22	70,3 ml/rev	105,4	100,0	95,5	2,3	26,1	44,1
	B25	79,3 ml/rev	118,9	113,5	109,0	2,5	29,2	49,5
	B28	88,8 ml/rev	133,2	127,7	124,5 ¹⁾	2,8	32,7	48,5 ¹⁾
	B31	100,0 ml/rev	150,0	144,5	141,3 ¹⁾	2,8	36,5	54,4 ¹⁾

¹⁾ B28 - B31 = 210 bar max. int. - Not to use because internal leakage greater than 50% theoretical flow
 Port connection can be furnished with metric threads.

Model No.

T6ED* - 066 - B38 - 1 R 00 - C 1 -

Series M = Mobile 1 shaft seal
 Series P = Mobile 2 shaft seals

Cam ring for "P1"
 (Delivery at 0 bar & 1500 r.p.m.)
 042 = 198,5 l/min 062 = 295,0 l/min
 045 = 213,6 l/min 066 = 319,9 l/min
 050 = 237,7 l/min 072 = 340,6 l/min
 052 = 247,2 l/min

Cam ring for "P2"
 (Delivery at 0 bar & 1500 r.p.m.)
 B14 = 71,4 l/min B35 = 166,5 l/min
 B17 = 87,3 l/min B38 = 180,4 l/min
 B20 = 99,0 l/min B42 = 204,0 l/min
 B24 = 119,3 l/min B45 = 218,5 l/min
 B28 = 134,5 l/min B50 = 237,0 l/min
 B31 = 147,4 l/min

Modification

Seal Class

- 1 = S1 (for mineral oil)
- 4 = S4 (for the resistant fluids)
- 5 = S5 (for mineral oil and fire resistant fluids)

Design letter

00 = standard

Direct. of rotation (view on shaft end)

- R = clockwise
- L = counter-clockwise

**Type of shaft
 P version**

3 = splined (no SAE)

**Type of shaft
 M version**

- 1 = keyed (SAE CC)
- 2 = keyed (no SAE)
- 3 = splined (SAE C)
- 4 = splined SAE CC
- T = splined (SAE J718c)

INTERNAL LEAKAGE (TYPICAL)

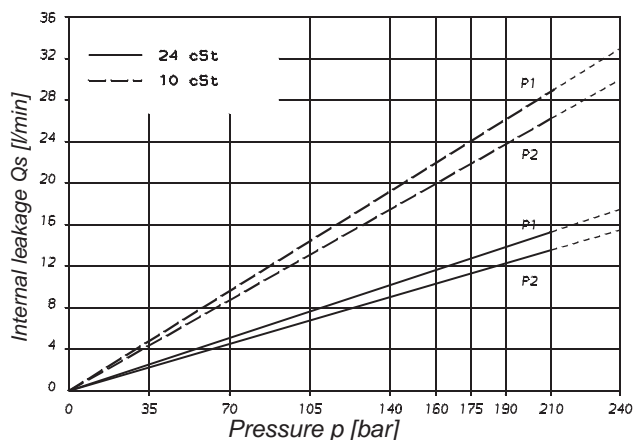

Total leakage is the sum of each section loss at its operating conditions.

**NOISE LEVEL (TYPICAL)
 T6EDM - 050 - B38**

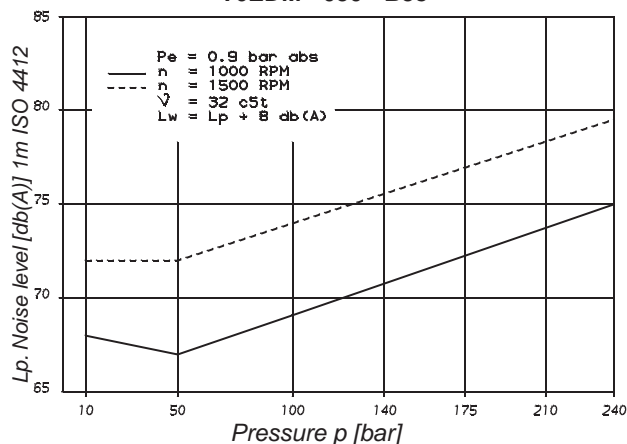

Double pump noise level is given with each section discharging at the pressure noted on the curve.

POWER LOSS HYDROMECHANICAL (TYPICAL)

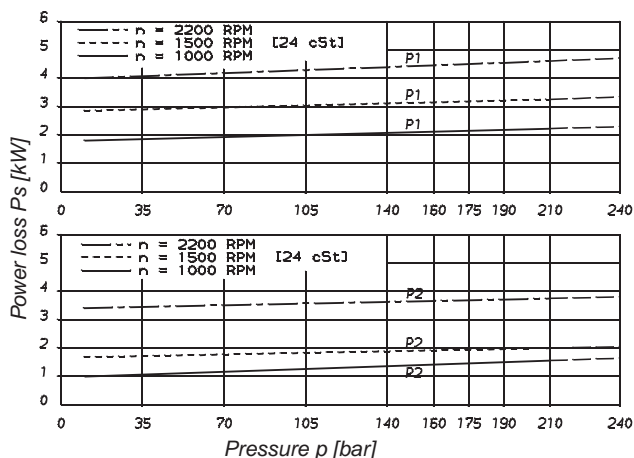

Total hydrodynamic power loss is the sum of each section at its operating conditions.

PERMISSIBLE RADIAL LOAD

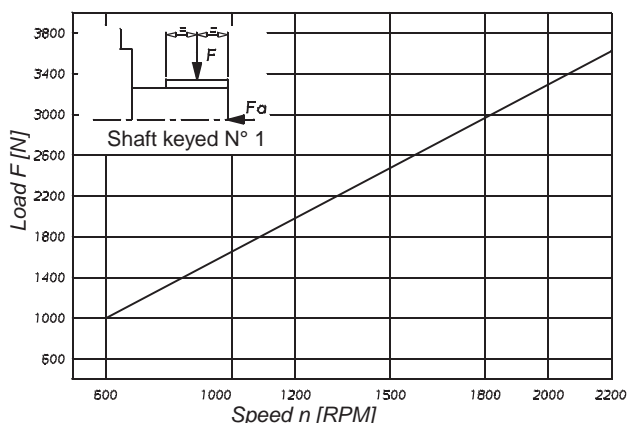

Maximum permissible axial load Fa = 2000 N

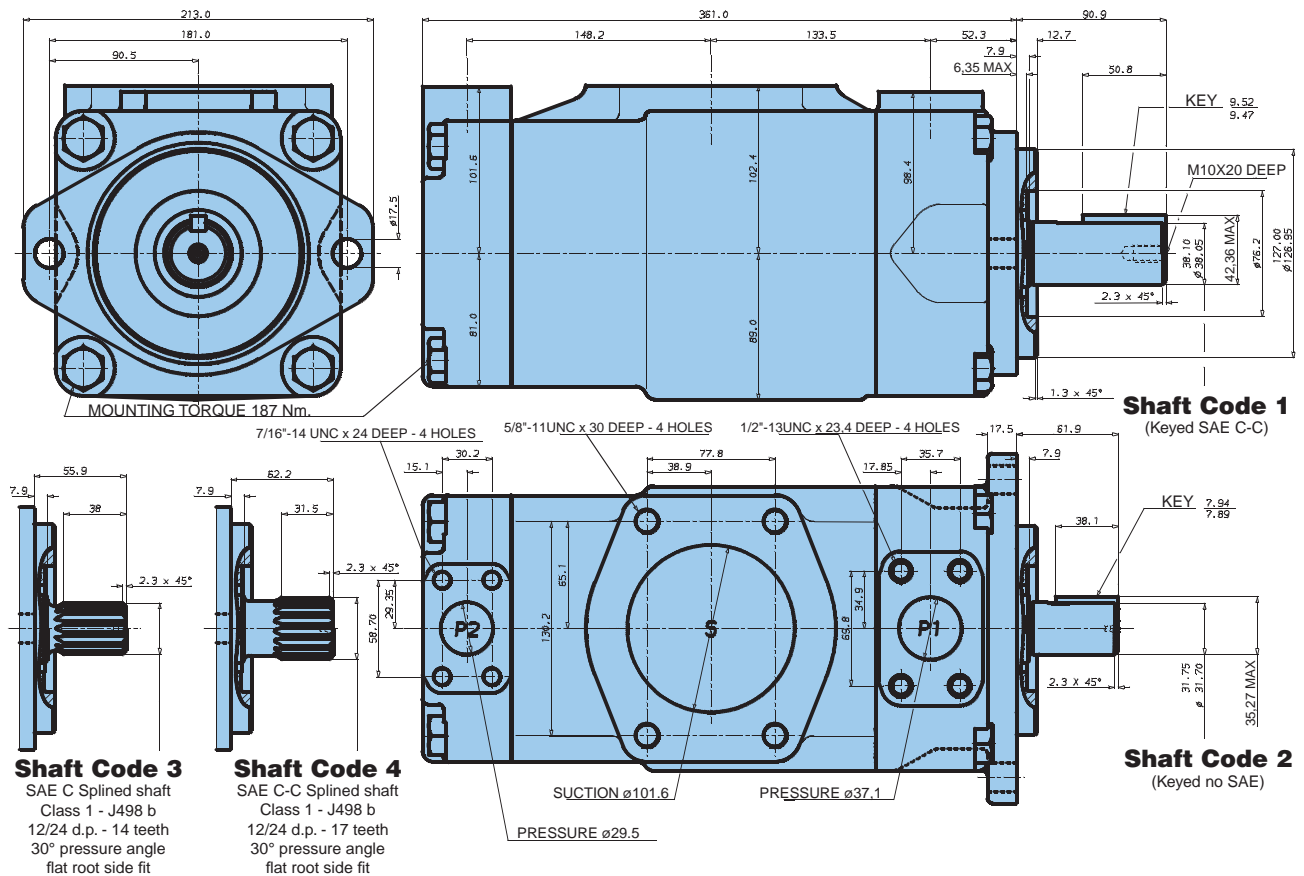

Shaft torque limits [ml/rev x bar]		
Pump	Shaft	Vi x p max. P1 + P2
T6EDM	1	72300
	2	34590
	3	61200
	4	68500

Additional T6EDM shaft code T: see page 33
 Additional T6EDP version shaft see page 33

OPERATING CHARACTERISTICS - TYPICAL [24 cSt]

Pressure port	Series	Volumetric Displacement Vi	Flow Q [l/min] & n = 1500 RPM			Flow Q [l/min] & n = 1500 RPM		
			p = 0 bar	p = 140 bar	p = 240 bar	p = 7 bar	p = 140 bar	p = 240 bar
P1	042	132,3 ml/rev	198,5	188,5	181,3	5,2	49,4	82,6
	045	142,4 ml/rev	213,6	203,6	196,5	5,4	52,9	88,7
	050	158,5 ml/rev	237,7	227,7	220,6	5,7	58,5	98,3
	052	164,8 ml/rev	247,2	237,2	230,1	5,8	60,8	102,1
	062	196,7 ml/rev	295,0	285,0	277,9	6,4	71,9	121,3
	066	213,3 ml/rev	319,9	309,9	302,8	6,7	77,7	131,2
	072	227,1 ml/rev	340,6	330,6	323,5	6,9	82,6	139,5
P2	B14	47,6 ml/rev	71,4	62,1	55,9	2,3	18,5	30,6
	B17	58,2 ml/rev	87,3	78,0	71,8	2,5	22,2	37,0
	B20	66,0 ml/rev	99,0	89,7	83,5	2,8	24,9	41,7
	B24	79,5 ml/rev	119,3	110,0	103,8	3,0	29,6	49,8
	B28	89,7 ml/rev	134,5	125,2	119,0	3,2	33,2	55,9
	B31	98,3 ml/rev	147,4	138,1	131,9	3,3	36,2	61,0
	B35	111,0 ml/rev	166,5	157,2	151,0	3,5	40,7	68,7
	B38	120,3 ml/rev	180,4	171,1	164,9	3,7	43,9	74,3
	B42	136,0 ml/rev	204,0	194,7	188,5	4,0	49,4	83,7
	B45	145,7 ml/rev	218,5	209,2	203,0	4,1	52,8	89,5
	B50	158,0 ml/rev	237,0	227,7	224,0 ¹⁾	4,4	57,0	85,0 ¹⁾

¹⁾ B50 = 210 bar max. int. Port connection can be furnished with metric threads.



Model No. T6DCCM - B38 - B28 - B08 - 1 R 00 - B 1 - 00

Series _____

Cam ring for "P1"
(Delivery at 0 bar & 1500 r.p.m.)
 B14 = 71,4 l/min B35 = 166,5 l/min
 B17 = 87,3 l/min B38 = 180,4 l/min
 B20 = 99,0 l/min B42 = 204,0 l/min
 B24 = 119,3 l/min B45 = 218,5 l/min
 B28 = 134,5 l/min B50 = 237,0 l/min
 B31 = 147,4 l/min

Cam ring for "P2" & "P3"
(Delivery at 0 bar & 1500 r.p.m.)
 B03 = 16,2 l/min B17 = 87,4 l/min
 B05 = 25,8 l/min B20 = 95,7 l/min
 B06 = 31,9 l/min B22 = 105,4 l/min
 B08 = 39,6 l/min B25 = 118,9 l/min
 B10 = 51,1 l/min B28 = 133,2 l/min
 B12 = 55,6 l/min B31 = 150,0 l/min
 B14 = 69,0 l/min

Modification

Mounting W/connection variables

Type	UNC		Metric	
	P3	1"	3/4"	1"
Code	00	01	M0	M1

Seal class

- 1 = S1 (for mineral oil)
- 4 = S4 (for the resistant fluids)
- 5 = S5 (for mineral oil and fire resistant fluids)

Design letter

Porting combination (see pages 34 - 35)

00 = standard

Direct. of rotation (view on shaft end)

- R = clockwise
- L = counter-clockwise

Type of shaft

- 1 = keyed (no SAE)
- 2 = keyed (SAE CC)
- 3 = splined (SAE C)
- 4 = splined (SAE CC)
- 6 = splined (no SAE)

OPERATING CHARACTERISTICS - TYPICAL [24 cSt]

Pressure port	Series	Volumetric Displacement Vi	Flow Q [l/min] & n = 1500 RPM			Input power P [kW] & n = 1500 RPM		
			p = 0 bar	p = 140 bar	p = 240 bar	p = 7 bar	p = 140 bar	p = 240 bar
P1	B14	47.6 ml/rev	71.4	62.1	55.9	2.3	18.5	30.6
	B17	58.2 ml/rev	87.3	78.0	71.8	2.5	22.2	37.0
	B20	66.0 ml/rev	99.0	89.7	83.5	2.8	24.9	41.7
	B24	79.5 ml/rev	119.3	110.0	103.8	3.0	29.6	49.8
	B28	89.7 ml/rev	134.5	125.2	119.0	3.2	33.2	55.9
	B31	98.3 ml/rev	147.4	138.1	131.9	3.3	36.2	61.0
	B35	111.0 ml/rev	166.5	157.2	151.0	3.5	40.7	68.7
	B38	120.3 ml/rev	180.4	171.1	164.9	3.7	43.9	74.3
	B42 ²⁾	136.0 ml/rev	204.0	194.7	188.5	4.0	49.4	83.7
	B45 ²⁾	145.7 ml/rev	218.5	209.2	203.0	4.1	52.8	89.5
B50 ²⁾	158.0 ml/rev	237.0	227.7	224.0 ¹⁾	4.4	57.0	85.0 ¹⁾	
P2 & P3	B03	10.8 ml/rev	16.2	10.7	-	1.3	5.3	-
	B05	17.2 ml/rev	25.8	20.3	15.8	1.4	7.5	12.2
	B06	21.3 ml/rev	31.9	26.5	22.0	1.5	8.9	14.7
	B08	26.4 ml/rev	39.6	34.1	29.6	1.6	10.7	17.7
	B10	34.1 ml/rev	51.1	45.7	41.2	1.7	13.4	22.3
	B12	37.1 ml/rev	55.6	50.2	45.7	1.7	14.4	24.1
	B14	46.0 ml/rev	69.0	63.5	59.0	1.9	17.6	29.5
	B17	58.3 ml/rev	87.4	82.0	77.5	2.1	21.9	36.9
	B20	63.8 ml/rev	95.7	90.2	85.7	2.2	23.8	40.2
	B22	70.3 ml/rev	105.4	100.0	95.5	2.3	26.1	44.1
	B25	79.3 ml/rev	118.9	113.5	109.0	2.5	29.2	49.5
	B28	88.8 ml/rev	133.2	127.7	124.5 ¹⁾	2.8	32.7	48.5 ¹⁾
B31	100.0 ml/rev	150.0	144.5	141.3 ¹⁾	2.8	36.5	54.4 ¹⁾	

¹⁾ B28 - B31 - B50 = 210 bar max. int. ²⁾ B42 - B45 - B50 = 2200 R.P.M. max
 - Not to use because internal leakage greater than 50% theoretical flow

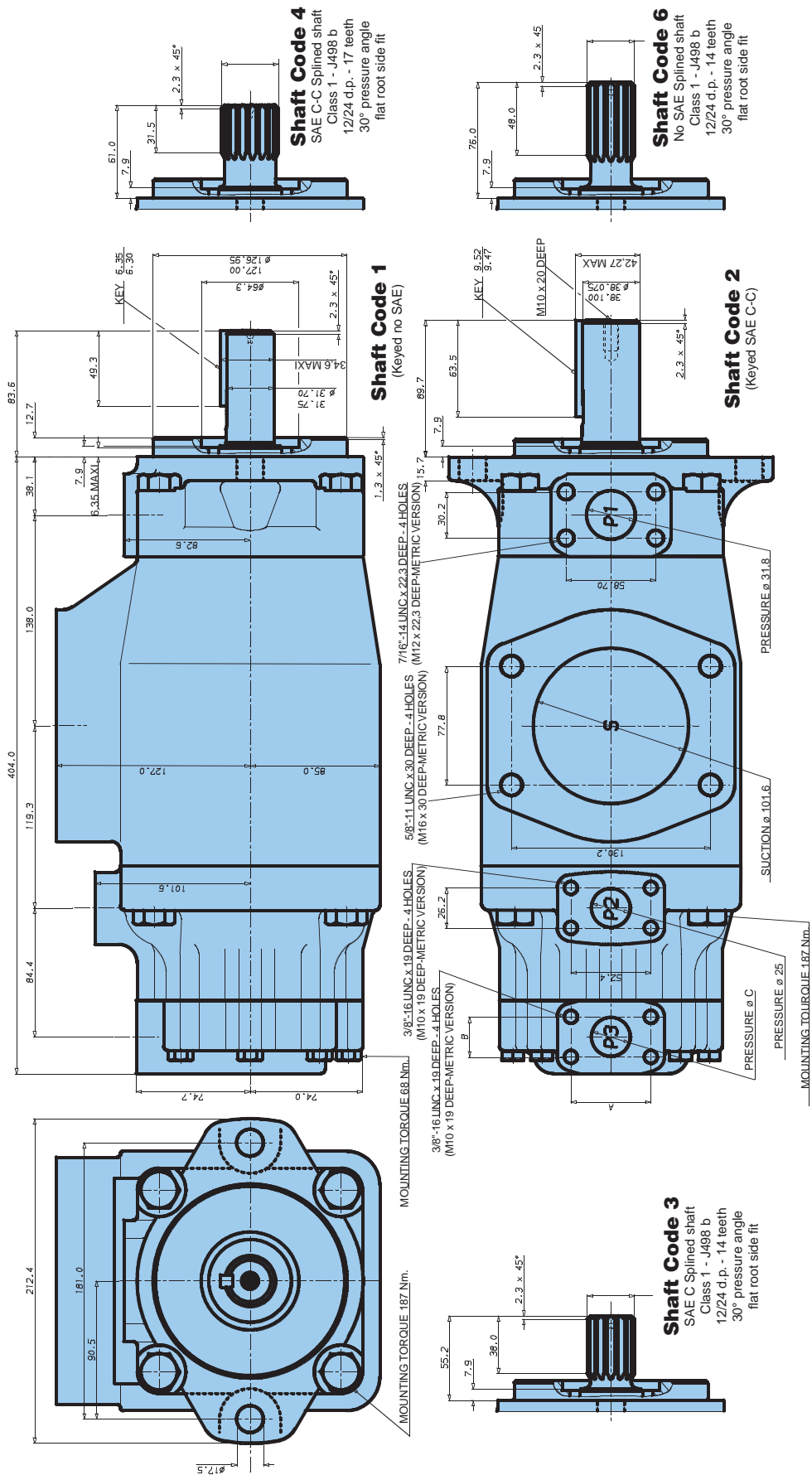

Alternate port		
Port	Code	
P3	00 & M0	25.4
P3	01 & M1	19.0

Shaft torque limits [ml/rev x bar]		
Pump	Shaft	Vi x p max. P1 + P2 + P3
T6DCCM	1	43240
	2	66500

INTERNAL LEAKAGE (TYPICAL)

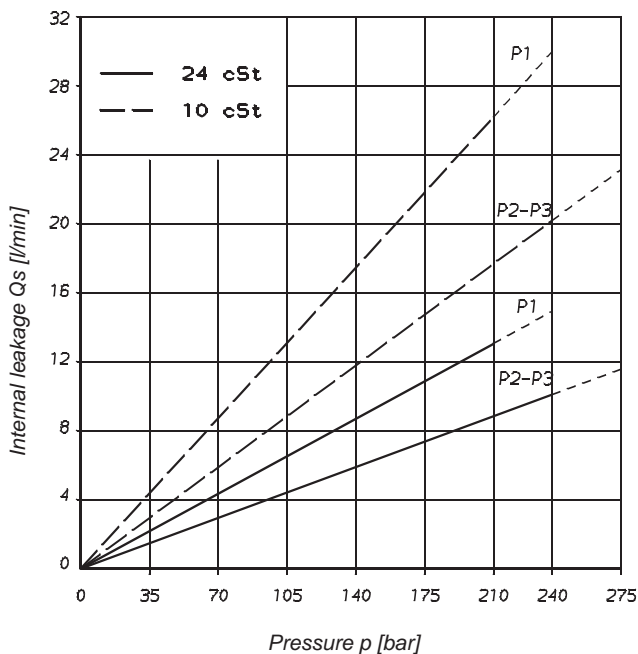

Total leakage is the sum of each section loss at its operating conditions.

NOISE LEVEL (TYPICAL)
 T6DCCM - B38 - B22 - B22

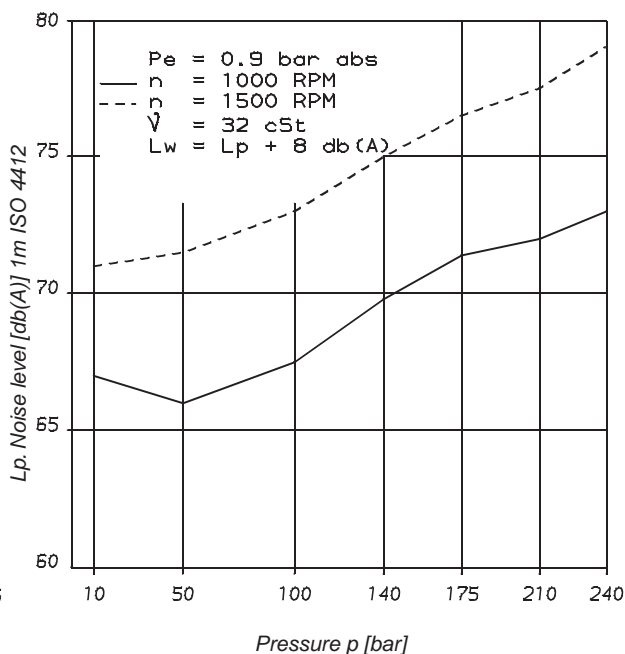

Triple pump noise level is given with each section discharging at the pressure noted on the curve.

POWER LOSS HYDROMECHANICAL (TYPICAL)

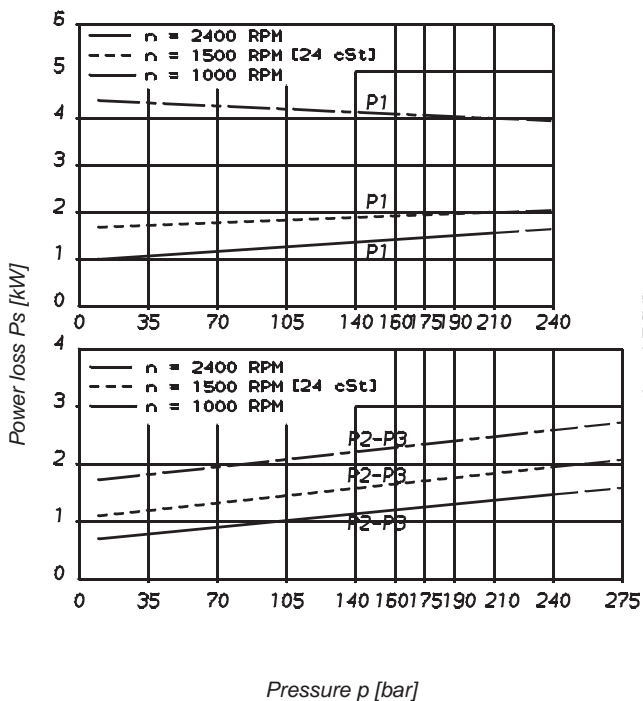

Total hydrodynamic power loss is the sum of each section at its operating conditions.

PERMISSIBLE RADIAL LOAD

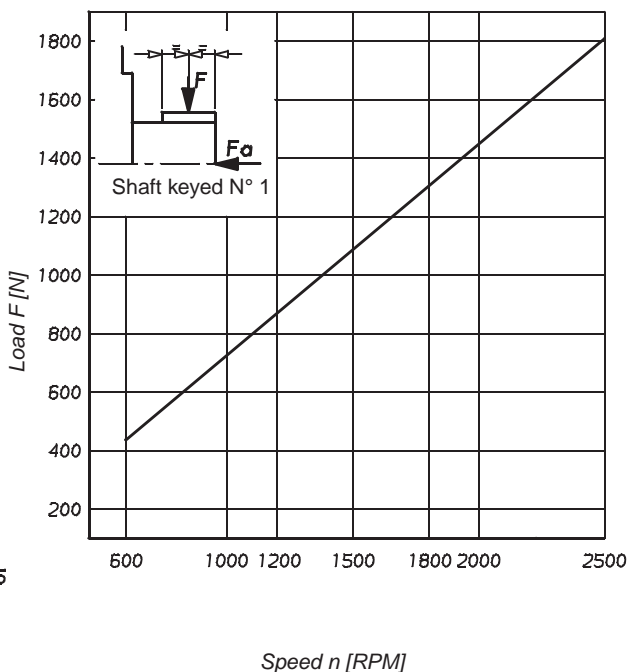

Maximum permissible axial load $F_a = 800$ N

INTERNAL LEAKAGE (TYPICAL)

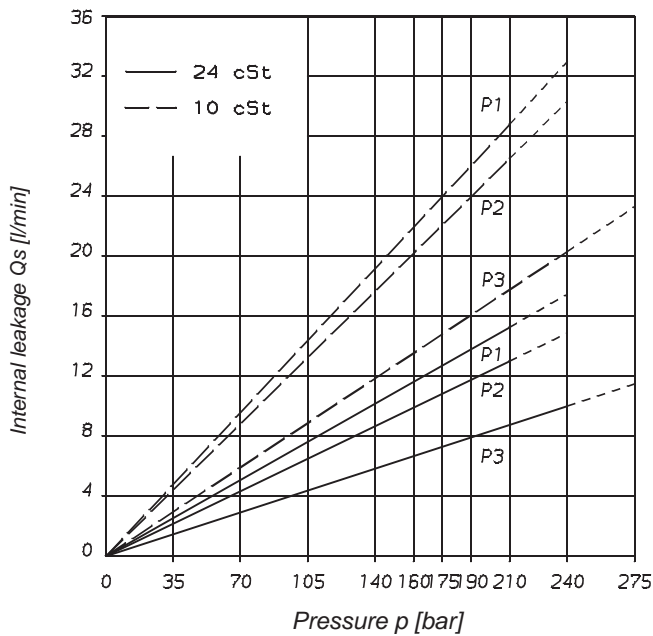

Total leakage is the sum of each section loss at its operating conditions.

NOISE LEVEL (TYPICAL)
T6EDCM - 062 - B35 - B17

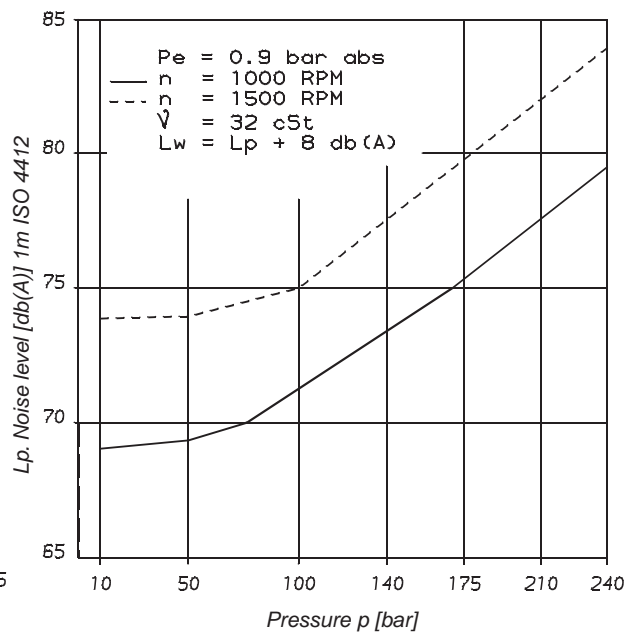

Triple pump noise level is given with each section discharging at the pressure noted on the curve.

POWER LOSS HYDROMECHANICAL (TYPICAL)

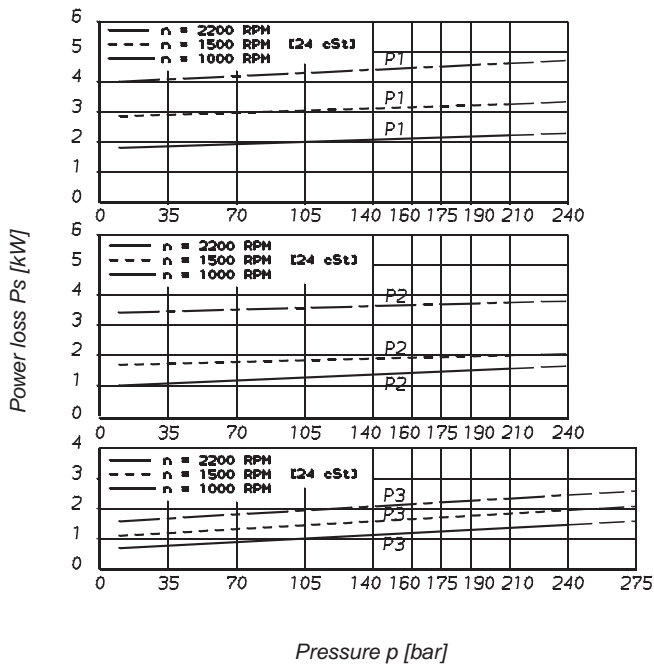

Total hydrodynamic power loss is the sum of each section at its operating conditions.

PERMISSIBLE RADIAL LOAD

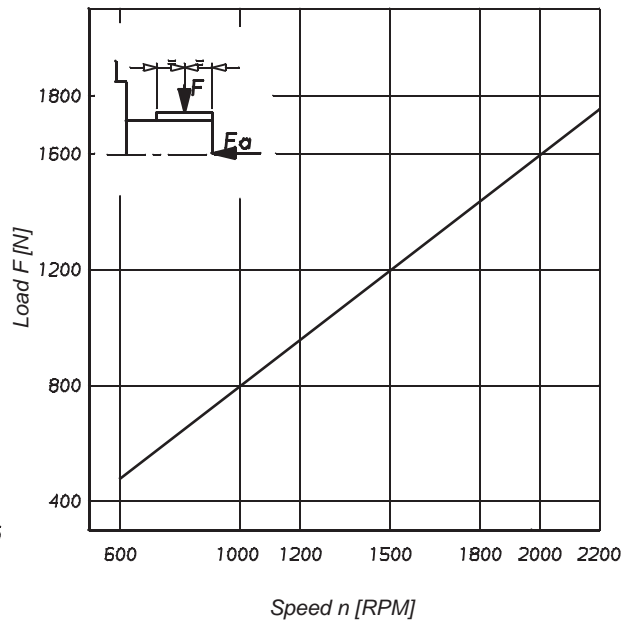

Maximum permissible axial load $F_a = 2000\text{ N}$

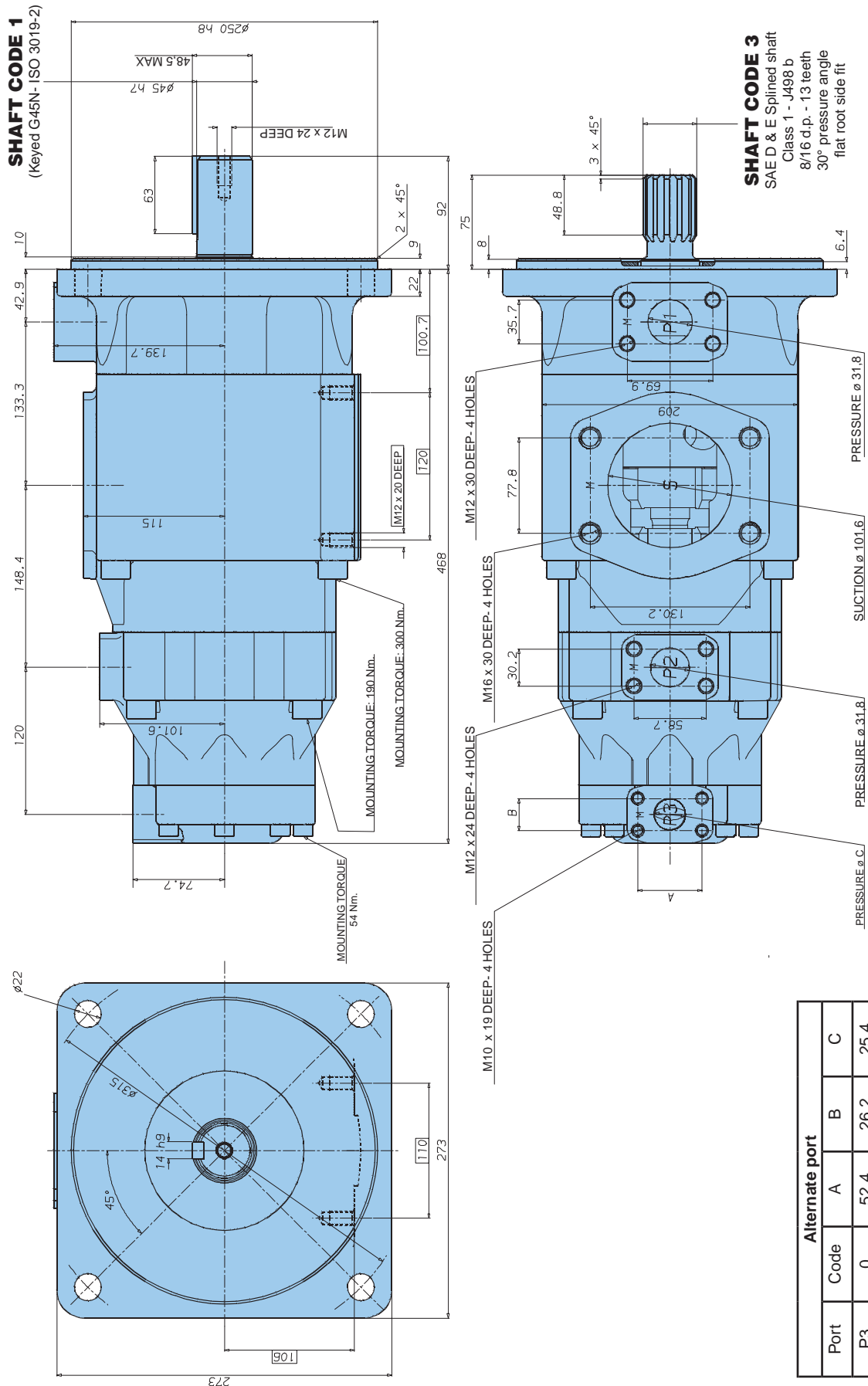

T6EDCS
T6EDCM - 062 - B35 - B17 - 1 R 00- A 1 - P 0 -

Model No.

Series _____

Cam ring for "P1"
(Delivery at 0 bar & 1500 r.p.m.)
042 = 198,5 l/min 062 = 295,0 l/min
045 = 213,6 l/min 066 = 319,9 l/min
050 = 237,7 l/min 072 = 340,6 l/min
052 = 247,2 l/min

Cam ring for "P2"
(Delivery at 0 bar & 1500 r.p.m.)
B14 = 71,4 l/min B35 = 166,5 l/min
B17 = 87,3 l/min B38 = 180,4 l/min
B20 = 99,0 l/min B42 = 204,0 l/min
B24 = 119,3 l/min B45 = 218,5 l/min
B28 = 134,5 l/min B50 = 237,0 l/min
B31 = 147,4 l/min

Cam ring for "P3"
(Delivery at 0 bar & 1500 r.p.m.)
B03 = 16,2 l/min B17 = 87,4 l/min
B05 = 25,8 l/min B20 = 95,7 l/min
B06 = 31,9 l/min B22 = 105,4 l/min
B08 = 39,6 l/min B25 = 118,9 l/min
B10 = 51,1 l/min B28 = 133,2 l/min
B12 = 55,6 l/min B31 = 150,0 l/min
B14 = 69,0 l/min

Modification
Mounting W/connection variables
0 = P3 = 1" SAE
1 = P3 = 3/4" SAE

Options
P = 4 holes for external support

Seal class
1 = S1 (for mineral oil)
4 = S4 (for the resistant fluids)
5 = S5 (for mineral oil and fire resistant fluids)

Design letter
Porting combination (see pages 34 - 35)
00 = standard

Direct. of rotation (view on shaft end)
R = clockwise
L = counter-clockwise

Type of shaft
1 = keyed (G45N - ISO 3019-2) (T6EDCM)
2 = keyed (SAE D & E) (T6EDCS)
3 = splined (SAE D & E) (T6EDCM-T6EDCS)

OPERATING CHARACTERISTICS - TYPICAL [24 cSt]

Pressure port	Series	Volumetric Displacement Vi	Flow Q [l/min] & n = 1500 RPM			Input power P [kW] & n = 1500 RPM		
			p = 0 bar	p = 140 bar	p = 240 bar	p = 7 bar	p = 140 bar	p = 240 bar
P1	042	132.3 ml/rev	198.5	188.5	181.3	5.2	49.4	82.6
	045	142.4 ml/rev	213.6	203.6	196.5	5.4	52.9	88.7
	050	158.5 ml/rev	237.7	227.7	220.6	5.7	58.5	98.3
	052	164.8 ml/rev	247.2	237.2	230.1	5.8	60.8	102.1
	062	196.7 ml/rev	295.0	285.0	277.9	6.4	71.9	121.3
	066	213.3 ml/rev	319.9	309.9	302.8	6.7	77.7	131.2
	072	227.1 ml/rev	340.6	330.6	323.5	6.9	82.6	139.5
P2	B14	47.6 ml/rev	71.4	62.1	55.9	2.3	18.5	30.6
	B17	58.2 ml/rev	87.3	78.0	71.8	2.5	22.2	37.0
	B20	66.0 ml/rev	99.0	89.7	83.5	2.8	24.9	41.7
	B24	79.5 ml/rev	119.3	110.0	103.8	3.0	29.6	49.8
	B28	89.7 ml/rev	134.5	125.2	119.0	3.2	33.2	55.9
	B31	98.3 ml/rev	147.4	138.1	131.9	3.3	36.2	61.0
	B35	111.0 ml/rev	166.5	157.2	151.0	3.5	40.7	68.7
	B38	120.3 ml/rev	180.4	171.1	164.9	3.7	43.9	74.3
	B42	136.0 ml/rev	204.0	194.7	188.5	4.0	49.4	83.7
	B45	145.7 ml/rev	218.5	209.2	203.0	4.1	52.8	89.5
P3	B50	158.0 ml/rev	237.0	227.7	224.0 ¹⁾	4.4	57.0	85.0 ¹⁾
	B03	10.8 ml/rev	16.2	10.7	-	1.3	5.3	-
	B05	17.2 ml/rev	25.8	20.3	15.8	1.4	7.5	12.2
	B06	21.3 ml/rev	31.9	26.5	22.0	1.5	8.9	14.7
	B08	26.4 ml/rev	39.6	34.1	29.6	1.6	10.7	17.7
	B10	34.1 ml/rev	51.1	45.7	41.2	1.7	13.4	22.3
	B12	37.1 ml/rev	55.6	50.2	45.7	1.7	14.4	24.1
	B14	46.0 ml/rev	69.0	63.5	59.0	1.9	17.6	29.5
	B17	58.3 ml/rev	87.4	80.0	77.5	2.1	21.9	36.9
	B20	63.8 ml/rev	95.7	90.2	85.7	2.2	23.8	40.2
	B22	70.3 ml/rev	105.4	100.0	95.5	2.3	26.1	44.1
	B25	79.3 ml/rev	118.9	113.5	109.0	2.5	29.2	49.5
	B28	88.8 ml/rev	133.2	127.7	124.5 ¹⁾	2.8	32.7	48.5 ¹⁾
B31	100.0 ml/rev	150.0	144.5	141.3 ¹⁾	2.8	36.5	54.4 ¹⁾	

¹⁾ B28 - B31 - B50 = 210 bar max. int. - Not to use because internal leakage greater than 50% theoretical flow

ADDITIONAL P VERSION

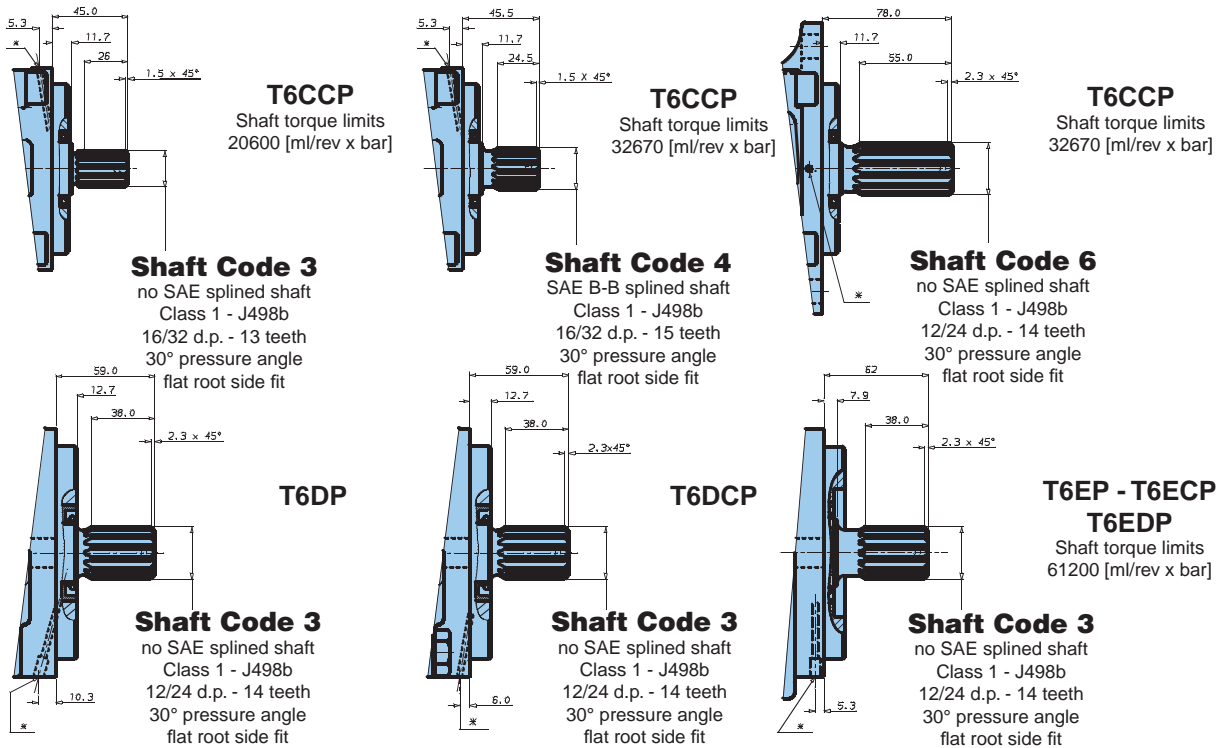

* Drain hole between double shaft seals.

ADDITIONAL SHAFT CODE T : 540 RPM POWER TAKE-OFF - SAE J718C FOR FARM TRACTORS

Shaft torque limits

T6CCMW - 32670 [ml/rev x bar]

T6DCMW - 66600 [ml/rev x bar]

T6EM - T6ECM - T6EDM - 70400 [ml/rev x bar]

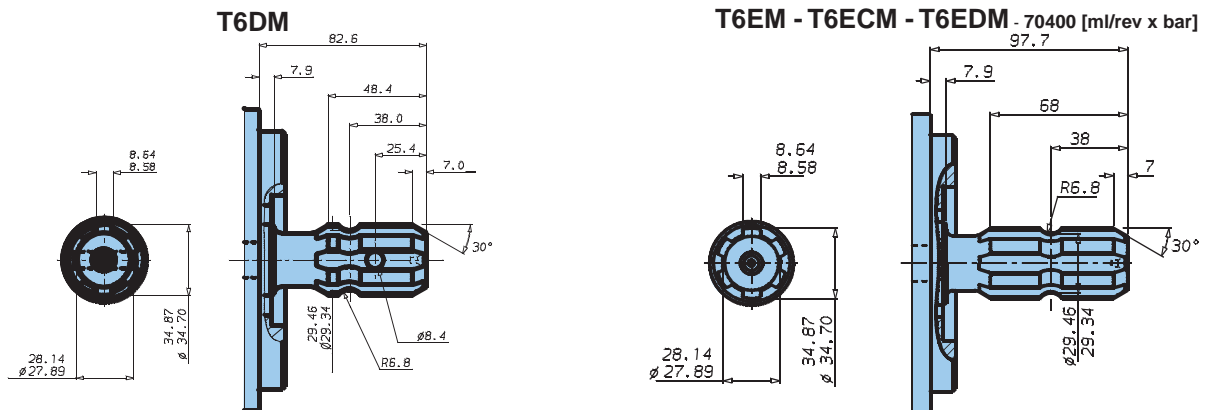

ADDITIONAL SPECIAL T6CCMW SHAFTS

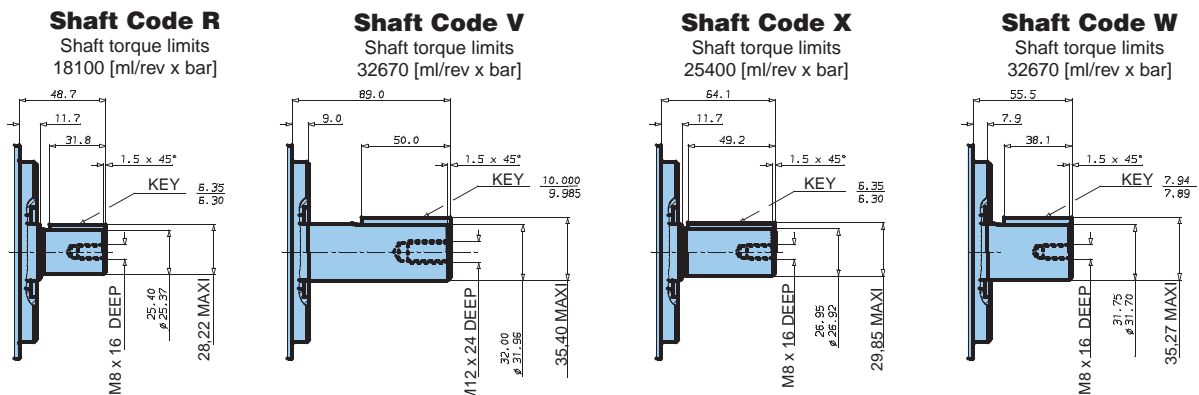

T6CC* - T6DC* - T6EC*

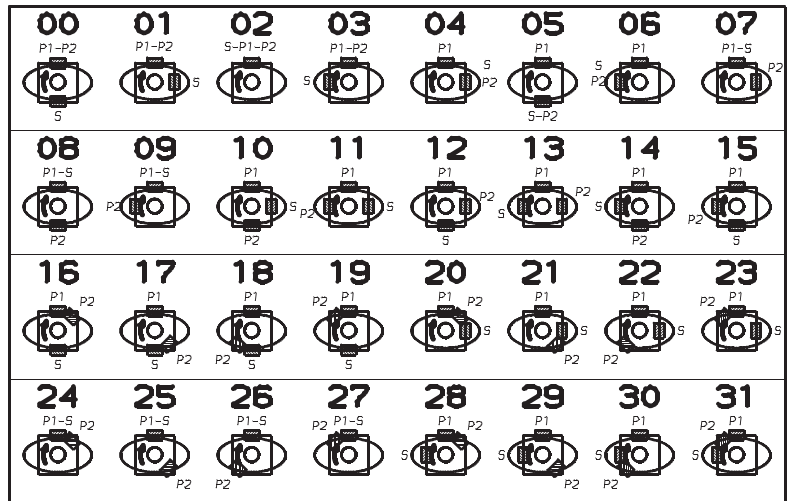

T6ED*

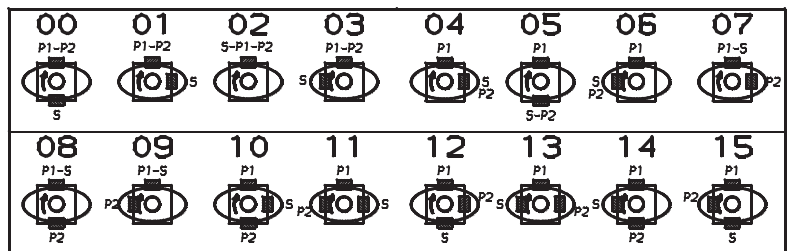



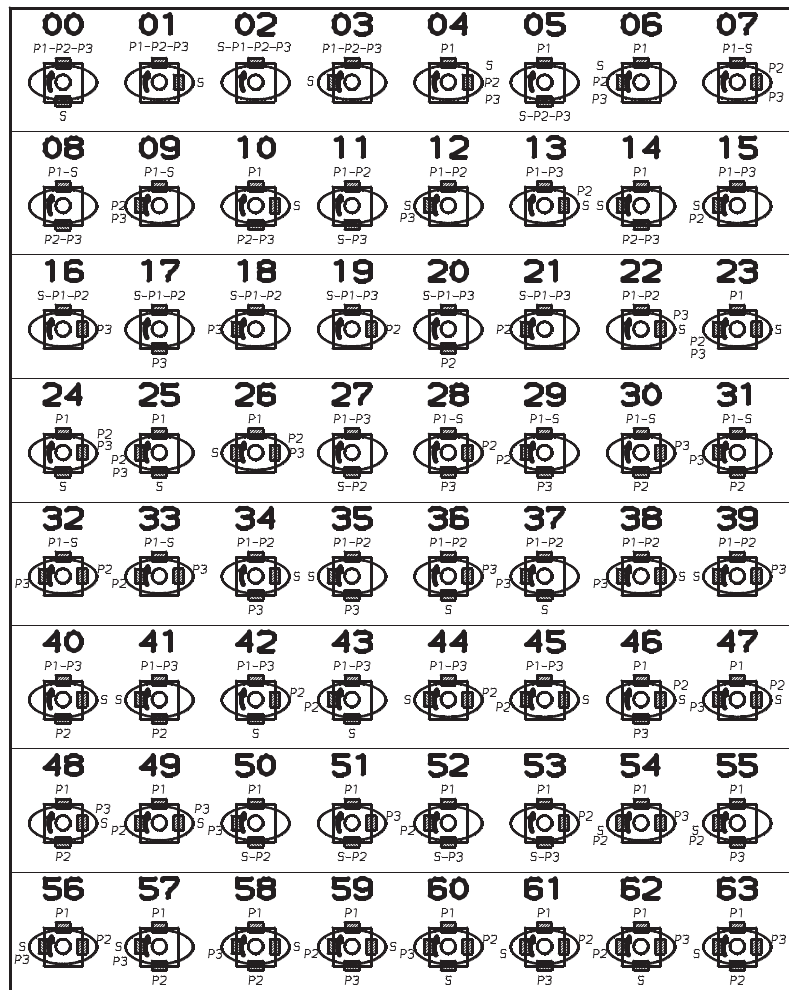

















































































T6DCCM - T6EDC*



T6DCCM - T6EDC*



S	P2	P3				P2	P3			
		02 	16 	17 	18 		20 	30 	08 	31 
		19 	07 	28 	32 		21 	33 	29 	09 
		01 	22 	34 	38 		40 	48 	10 	58 
		13 	04 	46 	47 		45 	49 	59 	23 
		00 	36 	11 	37 		27 	51 	05 	50 
		42 	24 	53 	60 		43 	62 	52 	25 
		03 	39 	35 	12 		41 	63 	14 	57 
		44 	26 	61 	56 		15 	54 	55 	06 

Parker Worldwide

AE – UAE, Dubai
Tel: +971 4 8127100
parker.me@parker.com

AR – Argentina, Buenos Aires
Tel: +54 3327 44 4129

AT – Austria, Wiener Neustadt
Tel: +43 (0)2622 23501-0
parker.austria@parker.com

AT – Eastern Europe, Wiener Neustadt
Tel: +43 (0)2622 23501 900
parker.easteurope@parker.com

AU – Australia, Castle Hill
Tel: +61 (0)2-9634 7777

AZ – Azerbaijan, Baku
Tel: +994 50 2233 458
parker.azerbaijan@parker.com

BE/LU – Belgium, Nivelles
Tel: +32 (0)67 280 900
parker.belgium@parker.com

BR – Brazil, Cachoeirinha RS
Tel: +55 51 3470 9144

BY – Belarus, Minsk
Tel: +375 17 209 9399
parker.belarus@parker.com

CA – Canada, Milton, Ontario
Tel: +1 905 693 3000

CH – Switzerland, Etoy
Tel: +41 (0) 21 821 02 30
parker.switzerland@parker.com

CL – Chile, Santiago
Tel: +56 2 623 1216

CN – China, Shanghai
Tel: +86 21 2899 5000

CZ – Czech Republic, Klecany
Tel: +420 284 083 111
parker.czechrepublic@parker.com

DE – Germany, Kaarst
Tel: +49 (0)2131 4016 0
parker.germany@parker.com

DK – Denmark, Ballerup
Tel: +45 43 56 04 00
parker.denmark@parker.com

ES – Spain, Madrid
Tel: +34 902 330 001
parker.spain@parker.com

FI – Finland, Vantaa
Tel: +358 (0)20 753 2500
parker.finland@parker.com

FR – France, Contamine s/Arve
Tel: +33 (0)4 50 25 80 25
parker.france@parker.com

GR – Greece, Athens
Tel: +30 210 933 6450
parker.greece@parker.com

HK – Hong Kong
Tel: +852 2428 8008

HU – Hungary, Budapest
Tel: +36 1 220 4155
parker.hungary@parker.com

IE – Ireland, Dublin
Tel: +353 (0)1 466 6370
parker.ireland@parker.com

IN – India, Mumbai
Tel: +91 22 6513 7081-85

IT – Italy, Corsico (MI)
Tel: +39 02 45 19 21
parker.italy@parker.com

JP – Japan, Fujisawa
Tel: +(81) 4 6635 3050

KR – South Korea, Seoul
Tel: +82 2 559 0400

KZ – Kazakhstan, Almaty
Tel: +7 7272 505 800
parker.easteurope@parker.com

LV – Latvia, Riga
Tel: +371 6 745 2601
parker.latvia@parker.com

MX – Mexico, Apodaca
Tel: +52 81 8156 6000

MY – Malaysia, Shah Alam
Tel: +60 3 7849 0800

NL – The Netherlands, Oldenzaal
Tel: +31 (0)541 585 000
parker.nl@parker.com

NO – Norway, Ski
Tel: +47 64 91 10 00
parker.norway@parker.com

NZ – New Zealand, Mt Wellington
Tel: +64 9 574 1744

PL – Poland, Warsaw
Tel: +48 (0)22 573 24 00
parker.poland@parker.com

PT – Portugal, Leca da Palmeira
Tel: +351 22 999 7360
parker.portugal@parker.com

RO – Romania, Bucharest
Tel: +40 21 252 1382
parker.romania@parker.com

RU – Russia, Moscow
Tel: +7 495 645-2156
parker.russia@parker.com

SE – Sweden, Spånga
Tel: +46 (0)8 59 79 50 00
parker.sweden@parker.com

SG – Singapore
Tel: +65 6887 6300

SK – Slovakia, Banská Bystrica
Tel: +421 484 162 252
parker.slovakia@parker.com

SL – Slovenia, Novo Mesto
Tel: +386 7 337 6650
parker.slovenia@parker.com

TH – Thailand, Bangkok
Tel: +662 717 8140

TR – Turkey, Istanbul
Tel: +90 216 4997081
parker.turkey@parker.com

TW – Taiwan, Taipei
Tel: +886 2 2298 8987

UA – Ukraine, Kiev
Tel: +380 44 494 2731
parker.ukraine@parker.com

UK – United Kingdom, Warwick
Tel: +44 (0)1926 317 878
parker.uk@parker.com

US – USA, Cleveland (industrial)
Tel: +1 216 896 3000

US – USA, Lincolnshire (mobile)
Tel: +1 847 821 1500

VE – Venezuela, Caracas
Tel: +58 212 238 5422

ZA – South Africa, Kempton Park
Tel: +27 (0)11 961 0700
parker.southafrica@parker.com

European Product Information Centre
Free phone: 00 800 27 27 5374
(from AT, BE, CH, CZ, DE, DK, EE, ES, FI, FR, IE, IL, IS, IT, LU, MT, NL, NO, PL, PT, RU, SE, UK, ZA)



Parker Hannifin Ltd.
Tachbrook Park Drive
Tachbrook Park, Warwick CV34 6TU
United Kingdom
Tel.: +44 (0) 1926 317 878
Fax: +44 (0) 1926 317 855
www.parker.com